

# JVC

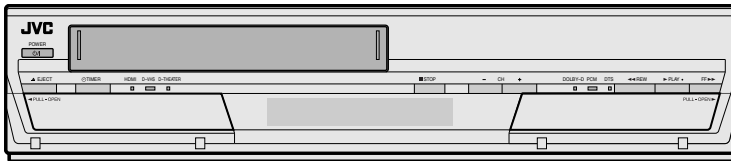

## D-VHS DIGITAL RECORDER

# HM-DH5U



**DVHS** MTP NTSC **DTHEATER**

**HDMI** **ds**  
DIGITAL OUT

**DOLBY** **PCM**  
DIGITAL

**SVHS**  
*Super VHS ET*

*Hi-Fi* **VCRplus<sup>+</sup>**  
CABLE BOX CONTROL

## INSTRUCTIONS

**For Customer Use:**

Enter below the Model No. and Serial No. which are located on the rear of cabinet. Retain this information for future reference.



Model No. \_\_\_\_\_

Serial No. \_\_\_\_\_

**Dear Customer,**

Thank you for purchasing the JVC D-VHS video cassette recorder. Before use, please read the safety information and precautions contained in the following pages to ensure safe use of your new VCR.

**CAUTIONS**

	<b>CAUTION</b> RISK OF ELECTRIC SHOCK DO NOT OPEN	
<p><b>CAUTION:</b> TO REDUCE THE RISK OF ELECTRIC SHOCK, DO NOT REMOVE COVER (OR BACK). NO USER-SERVICEABLE PARTS INSIDE. REFER SERVICING TO QUALIFIED SERVICE PERSONNEL.</p>		



The lightning flash with arrowhead symbol, within an equilateral triangle, is intended to alert the user to the presence of uninsulated "dangerous voltage" within the product's enclosure that may be of sufficient magnitude to constitute a risk of electric shock to persons.



The exclamation point within an equilateral triangle is intended to alert the user to the presence of important operating and maintenance (servicing) instructions in the literature accompanying the appliance.

**WARNING:**

**TO PREVENT FIRE OR SHOCK HAZARD, DO NOT EXPOSE THIS UNIT TO RAIN OR MOISTURE.**

**CAUTION:**

This video cassette recorder should be used with AC 120V~, 60Hz only.

To prevent electric shocks and fire hazards, DO NOT use any other power source.

**CAUTION:**

TO PREVENT ELECTRIC SHOCK, MATCH WIDE BLADE OF PLUG TO WIDE SLOT, FULLY INSERT.

**ATTENTION:**

POUR ÉVITER LES CHOCS ÉLECTRIQUES, INTRODUIRE LA LAME LA PLUS LARGE DE LA FICHE DANS LA BORNE CORRESPONDANTE DE LA PRISE ET POUSSER JUSQU'AU FOND.

**Note to CATV system installer:**

This reminder is provided to call the CATV system installer's attention to Article 820-40 of the NEC that provides guidelines for proper grounding and, in particular, specifies that the cable ground shall be connected to the grounding system of the building, as close to the point of cable entry as practical.

**NOTE:**

Change or modifications not approved by the party responsible for compliance could void the user's authority to operate the equipment.

This equipment has been tested and found to comply with the limits for a Class B digital device, pursuant to Part 15 of the FCC Rules. These limits are designed to provide reasonable protection against harmful interference in a residential installation. This equipment generates, uses, and can radiate radio frequency energy and, if not installed and used in accordance with the instructions, may cause harmful interference to radio communications. However, there is no guarantee that interference will not occur in a particular installation. If this equipment does cause harmful interference to radio or television reception, which can be determined by turning the equipment off and on, the user is encouraged to try to correct the interference by one or more of the following measures:

- Reorient or relocate the receiving antenna.
- Increase the separation between the equipment and receiver.
- Connect the equipment into an outlet on a circuit different from that to which the receiver is connected.
- Consult the dealer or an experienced radio/TV technician for help.

When the equipment is installed in a cabinet or a shelf, make sure that it has sufficient space on all sides to allow for ventilation (10 cm or more on both sides, on top and at the rear).

When discarding batteries, environmental problems must be considered and the local rules or laws governing the disposal of these batteries must be followed strictly.

VCR Plus+, C<sup>3</sup> and PlusCode are registered trademarks of Gemstar Development Corporation. The VCR Plus+ system is manufactured under license from Gemstar Development Corporation.

DSS™ is an official trademark of DIRECTV, Inc., a unit of GM Hughes Electronics. DISH Network™ is a trademark of Echostar Communications Corporation.

D-Theater is a technical specification based on D-VHS standards that was developed for HD content. Commercial D-Theater titles can only be played back on D-VHS digital recorders bearing the D-Theater logo.

DTS, DTS Digital Out are trademarks of Digital Theater Systems, Inc.

HDMI, the HDMI logo and High-Definition Multimedia Interface are trademarks or registered trademarks of HDMI Licensing LLC.



- Cassettes marked D-VHS, S-VHS and VHS can be used with this video cassette recorder. However, D-VHS recordings are possible only with cassettes marked D-VHS.  
By using S-VHS ET it is possible to record and play back with S-VHS picture quality on VHS cassettes with this VCR.
- D-VHS is a new digital memory system that uses D-VHS tapes. D-VHS was developed as a memory system for multimedia applications that require storage for large volumes of information, such as for digital video.
- D-VHS tapes recorded on video products not using the D-VHS MTP/NTSC standard cannot be played back on this VCR.
- Manufactured under license from Dolby Laboratories. Dolby, Pro Logic, and the double-D symbol are trademarks of Dolby Laboratories. Confidential unpublished works. Copyright 1992-1997 Dolby Laboratories. All rights reserved.

## IMPORTANT PRODUCT SAFETY INSTRUCTIONS

Electrical energy can perform many useful functions. But improper use can result in potential electrical shock or fire hazards. This product has been engineered and manufactured to assure your personal safety. In order not to defeat the built-in safeguards, observe the following basic rules for its installation, use and servicing.

### ATTENTION:

Follow and obey all warnings and instructions marked on your product and its operating instructions. For your safety, please read all the safety and operating instructions before you operate this product and keep this booklet for future reference.

## INSTALLATION

### 1. Grounding or Polarization

(A) Your product may be equipped with a polarized alternating-current line plug (a plug having one blade wider than the other). This plug will fit into the power outlet only one way. This is a safety feature.

If you are unable to insert the plug fully into the outlet, try reversing the plug. If the plug should still fail to fit, contact your electrician to replace your obsolete outlet. Do not defeat the safety purpose of the polarized plug.

(B) Your product may be equipped with a 3-wire grounding-type plug, a plug having a third (grounding) pin. This plug will only fit into a grounding-type power outlet. This is a safety feature.

If you are unable to insert the plug into the outlet, contact your electrician to replace your obsolete outlet. Do not defeat the safety purpose of the grounding-type plug.

### 2. Power Sources

Operate your product only from the type of power source indicated on the marking label. If you are not sure of the type of power supply to your home, consult your product dealer or local power company. If your product is intended to operate from battery power, or other sources, refer to the operating instructions.

### 3. Overloading

Do not overload wall outlets, extension cords, or integral convenience receptacles as this can result in a risk of fire or electric shock.

### 4. Power Cord Protection

Power supply cords should be routed so that they are not likely to be walked on or pinched by items placed upon or against them, paying particular attention to cords at plugs, convenience receptacles, and the point where they exit from the product.

### 5. Ventilation

Slots and openings in the cabinet are provided for ventilation. To ensure reliable operation of the product and to protect it from overheating, these openings must not be blocked or covered.

- Do not block the openings by placing the product on a bed, sofa, rug or other similar surface.
- Do not place the product in a built-in installation such as a bookcase or rack unless proper ventilation is provided or the manufacturer's instructions have been adhered to.

### 6. Wall or Ceiling Mounting

The product should be mounted to a wall or ceiling only as recommended by the manufacturer.

## ANTENNA INSTALLATION INSTRUCTIONS

### 1. Outdoor Antenna Grounding

If an outside antenna or cable system is connected to the product, be sure the antenna or cable system is grounded so as to provide some protection against voltage surges and built-up static charges. Article 810 of the National Electrical Code, ANSI/NFPA 70, provides information with regard to proper grounding of the mast and supporting structure, grounding of the lead-in wire to an antenna discharge unit, size of grounding connectors, location of antenna discharge unit, connection to grounding electrodes, and requirements for the grounding electrode.

### 2. Lightning

For added protection for this product during a lightning storm, or when it is left unattended and unused for long periods of time, unplug it from the wall outlet and disconnect the antenna or cable system. This will prevent damage to the product due to lightning and power-line surges.

### 3. Power Lines

An outside antenna system should not be located in the vicinity of overhead power lines or other electric light or power circuits, or where it can fall into such power lines or circuits. When installing an outside antenna system, extreme care should be taken to keep from touching such power lines or circuits as contact with them might be fatal.

EXAMPLE OF ANTENNA GROUNDING AS PER NATIONAL ELECTRICAL CODE, ANSI/NFPA 70

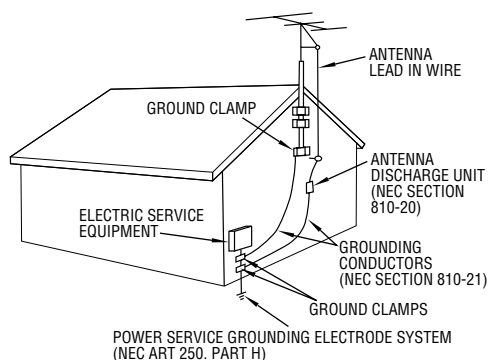

NEC - NATIONAL ELECTRICAL CODE

## USE

### 1. Accessories

To avoid personal injury:

- Do not place this product on an unstable cart, stand, tripod, bracket, or table. It may fall, causing serious injury to a child or adult, and serious damage to the product.
- Use only with a cart, stand, tripod, bracket, or table recommended by the manufacturer or sold with the product.
- Use a mounting accessory recommended by the manufacturer and follow the manufacturer's instructions for any mounting of the product.
- Do not try to roll a cart with small casters across thresholds or deep-pile carpets.

### 2. Product and Cart Combination

A product and cart combination should be moved with care. Quick stops, excessive force, and uneven surfaces may cause the product and cart combination to overturn.

**PORTABLE CART WARNING**  
(Symbol provided by RETAC)



### 3. Water and Moisture

Do not use this product near water—for example, near a bath tub, wash bowl, kitchen sink or laundry tub, in a wet basement, or near a swimming pool and the like.

### 4. Object and Liquid Entry

Never push objects of any kind into this product through openings as they may touch dangerous voltage points or short-out parts that could result in a fire or electric shock. Never spill liquid of any kind on the product.

### 5. Attachments

Do not use attachments not recommended by the manufacturer of this product as they may cause hazards.

### 6. Cleaning

Unplug this product from the wall outlet before cleaning. Do not use liquid cleaners or aerosol cleaners. Use a damp cloth for cleaning.

### 7. Heat

The product should be situated away from heat sources such as radiators, heat registers, stoves, or other products (including amplifiers) that produce heat.

## SERVICING

### 1. Servicing

If your product is not operating correctly or exhibits a marked change in performance and you are unable to restore normal operation by following the detailed procedure in its operating instructions, do not attempt to service it yourself as opening or removing covers may expose you to dangerous voltage or other hazards. Refer all servicing to qualified service personnel.

### 2. Damage Requiring Service

Unplug this product from the wall outlet and refer servicing to qualified service personnel under the following conditions:

- a. When the power supply cord or plug is damaged.
- b. If liquid has been spilled, or objects have fallen into the product.
- c. If the product has been exposed to rain or water.
- d. If the product does not operate normally by following the operating instructions. Adjust only those controls that are covered by the operating instructions as an improper adjustment of other controls may result in damage and will often require extensive work by a qualified technician to restore the product to its normal operation.
- e. If the product has been dropped or damaged in any way.
- f. When the product exhibits a distinct change in performance—this indicates a need for service.

### 3. Replacement Parts

When replacement parts are required, be sure the service technician has used replacement parts specified by the manufacturer or which have the same characteristics as the original part. Unauthorized substitutions may result in fire, electric shock or other hazards.

### 4. Safety Check

Upon completion of any service or repairs to this product, ask the service technician to perform safety checks to determine that the product is in safe operating condition.

## HOW TO USE THIS INSTRUCTION MANUAL

- The Index on pages 7 - 11 illustrates the controls and connections on the front and rear panel, the front display panel and the Remote.
- The list of terms on page 88 lists frequently-used terms, and the number of the page on which they are used or explained in the manual.
- The  mark signals a reference to another page for instructions or related information.
- Operation buttons necessary for the various procedures are clearly indicated through the use of illustrations at the beginning of each major section.

## BEFORE YOU INSTALL YOUR NEW VCR . . .

. . . please read the sections/literature listed below.

- 'CAUTIONS' on page 2.
- 'IMPORTANT PRODUCT SAFETY INSTRUCTIONS' on the previous page.

Failure to heed the following precautions may result in damage to the VCR, Remote or video cassette.

1. **DO NOT place the VCR...**
  - ... in an environment prone to extreme temperatures or humidity.
  - ... in direct sunlight.
  - ... in a dusty environment.
  - ... in an environment where strong magnetic fields are generated.
  - ... on a surface that is unstable or subject to vibration.
2. **DO NOT block the VCR's ventilation openings or holes.**  
(If the ventilation openings or holes are blocked by a newspaper or cloth, etc., the heat may not be able to get out.)
3. **DO NOT place heavy objects on the VCR or Remote.**
4. **DO NOT place anything which might spill on top of the VCR or Remote.**  
(If water or liquid is allowed to enter this equipment, fire or electric shock may be caused.)
5. **DO NOT expose the apparatus to dripping or splashing.**
6. **DO NOT use this equipment in a bathroom or places with water. Also DO NOT place any containers filled with water or liquids (such as cosmetics or medicines, flower vases, potted plants, cups, etc.) on top of this unit.**
7. **DO NOT place any naked flame sources, such as lighted candles, on the apparatus.**
8. **AVOID violent shocks to the VCR during transport.**

### MOISTURE CONDENSATION

Moisture in the air will condense on the VCR when you move it from a cold place to a warm place, or under extremely humid conditions—just as water droplets form on the surface of a glass filled with cold liquid. Moisture condensation on the head drum will cause damage to the tape. In conditions where condensation may occur, keep the VCR turned on for a few hours to let the moisture evaporate.

### ABOUT HEAD CLEANING

After an extended period of use, the video heads can become dirty, resulting in a loss of picture or sound during playback. If this happens, clean the video heads by using the optional cleaning tapes.

The heads get dirty in the following cases:

- in an environment prone to extreme temperature or humidity.
- in a dusty environment.
- flaw, dirt or mold on video tapes.
- continuous usage for a long time.

#### Symptoms of dirty video heads:

- The picture is not clear, or does not appear. There is no sound.
- Mosaic (block) noise appears in the picture.
- Black or mosaic horizontal stripes appear in the picture.
- The picture stops (as if the tape is paused).
- A blank black or blue screen appears.
- The picture is fuzzy. (VHS playback)

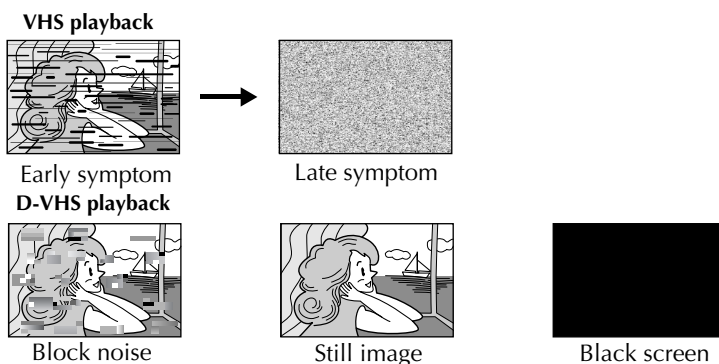

Use a cleaning tape designed specifically for D-VHS video heads (JVC D-VHS video head cleaner DFC-2) to clean the video heads.

- In order to avoid misoperation, set "NAVIGATION" to "OFF" (see page 52).
- Follow the instructions that are provided with the cleaning tape.

If you still do not get a clear picture after using a cleaning tape:

- The heads may be worn. Contact your nearest JVC dealer.
- During VHS playback, if there is a tracking problem, the picture may appear fuzzy. Adjust the tracking manually (see page 30).

### ATTENTION:

#### To mobile phone users:

Using a mobile phone in the vicinity of the VCR may cause picture vibration on the TV screen or change the screen to a blue back display.

#### On placing the VCR:

Some TVs or other appliances generates strong magnetic fields. Do not place such appliance on top of the VCR as it may cause picture disturbance.

<b>INDEX</b> .....	<b>7</b>	<b>RECORDING</b> .....	<b>35</b>
<b>Front panel</b> .....	<b>7</b>	<b>Basic Recording</b> .....	<b>35</b>
<b>Rear panel</b> .....	<b>8</b>	D-VHS Recording via i.LINK Connection.....	35
<b>Front display panel</b> .....	<b>9</b>	D-VHS/S-VHS/VHS Recording.....	36
<b>On-screen display</b> .....	<b>10</b>	<b>Basic Recording Features</b> .....	<b>37</b>
<b>Remote</b> .....	<b>11</b>	Changing display information.....	37
<b>INSTALLING YOUR NEW VCR</b> .....	<b>12</b>	Specifying recording length	
<b>Connections</b> .....	<b>12</b>	— Instant Timer Recording (ITR).....	37
Basic Connection.....	13	Watching one program while recording another.....	38
Digital Set Top Box Connection.....	15	Showing on-screen display.....	38
<b>INITIAL SETTINGS</b> .....	<b>16</b>	<b>TIMER RECORDING</b> .....	<b>40</b>
<b>Plug &amp; Play Setting</b> .....	<b>16</b>	<b>VCR Plus+ C<sup>3</sup>® Timer Programming</b> .....	<b>40</b>
Auto Clock Set/Auto Tuner Set.....	16	<b>Changing VCR Plus+ C<sup>3</sup>® Setting</b> .....	<b>42</b>
<b>Clock Setting</b> .....	<b>17</b>	<b>Express Timer Programming</b> .....	<b>44</b>
Preparations.....	17	Checking program settings.....	46
Setting clock semiautomatically		Canceling or changing program settings.....	46
— Semiauto Clock Set.....	18	<b>Satellite Auto Recording</b> .....	<b>47</b>
Setting clock manually		<b>i.LINK Timer Programming</b> .....	<b>48</b>
— Manual Clock Set.....	19	<b>Video Remote Control Timer Programming</b> ..	<b>49</b>
<b>Tuner Setting</b> .....	<b>20</b>	<b>VIDEO NAVIGATION</b> .....	<b>51</b>
Setting channels automatically		<b>Navigation Playback</b> .....	<b>51</b>
— Auto Channel Set.....	20	Deactivating Video Navigation.....	52
Setting channels manually		<b>Finding Tapes</b> .....	<b>53</b>
— Manual Channel Set.....	21	Finding by tape number.....	53
<b>Cable Box Control Setting</b> .....	<b>22</b>	Finding by program title.....	54
Installing Controller.....	22	Finding by category.....	54
Setting cable box input channel & brand.....	23	Finding by recording date.....	55
<b>DBS Receiver Control Setting</b> .....	<b>25</b>	Finding blank space.....	56
Installing Controller.....	25	<b>Editing Titles</b> .....	<b>57</b>
Setting DBS receiver input channel & brand.....	26	Editing tape title.....	57
<b>PLAYBACK</b> .....	<b>28</b>	Entering or Editing program title.....	59
<b>Basic Playback</b> .....	<b>28</b>	Editing program category.....	60
<b>Basic Playback Features</b> .....	<b>29</b>	Deleting tape information.....	60
Checking tape position.....	29	Deleting program information.....	61
Playing back tape repeatedly		Checking memory.....	61
— Repeat Playback.....	29	<b>OTHER USEFUL FUNCTIONS</b> .....	<b>62</b>
Adjusting tracking condition		<b>Useful Function Settings</b> .....	<b>62</b>
— Tracking Adjustments.....	30	<b>JLIP ID Number Setting</b> .....	<b>69</b>
Selecting monitor sound		<b>i.LINK Set Up</b> .....	<b>70</b>
— Audio Monitor.....	30	<b>EDITING</b> .....	<b>72</b>
Automatic operations after rewinding		<b>i.LINK/DV Connections</b> .....	<b>72</b>
— Next Function Memory.....	31	<b>S-VIDEO/VIDEO Connections</b> .....	<b>74</b>
Locating beginning of recordings		<b>MULTI-BRAND REMOTE CONTROL</b> .....	<b>76</b>
— Index Search.....	31	<b>TV Brand Setting</b> .....	<b>76</b>
Skipping unwanted portions		<b>Cable Box or DBS Receiver Brand Setting</b> .....	<b>77</b>
— Skip Search.....	31	<b>Changing Remote Control Code</b> .....	<b>78</b>
<b>Special Effect Playback</b> .....	<b>33</b>	<b>TROUBLESHOOTING</b> .....	<b>79</b>
Locating particular scene rapidly		<b>Error Codes and Messages</b> .....	<b>84</b>
— Picture Search.....	33	<b>Questions and answers</b> .....	<b>86</b>
High-Speed Picture Search.....	33	<b>GLOSSARY</b> .....	<b>87</b>
Variable-Speed Picture Search.....	33	<b>LIST OF TERMS</b> .....	<b>88</b>
Viewing still picture		<b>SPECIFICATIONS</b> .....	<b>89</b>
— Still Picture Playback.....	34	<b>WARRANTY (Only in U.S.A.)</b> .....	<b>90</b>
Viewing still picture frame by frame		<b>FOR SERVICING (Only in U.S.A.)</b> .....	<b>92</b>
— Frame-by-Frame Playback.....	34		
Viewing slow motion picture			
— Slow Motion Playback.....	34		

# Front panel

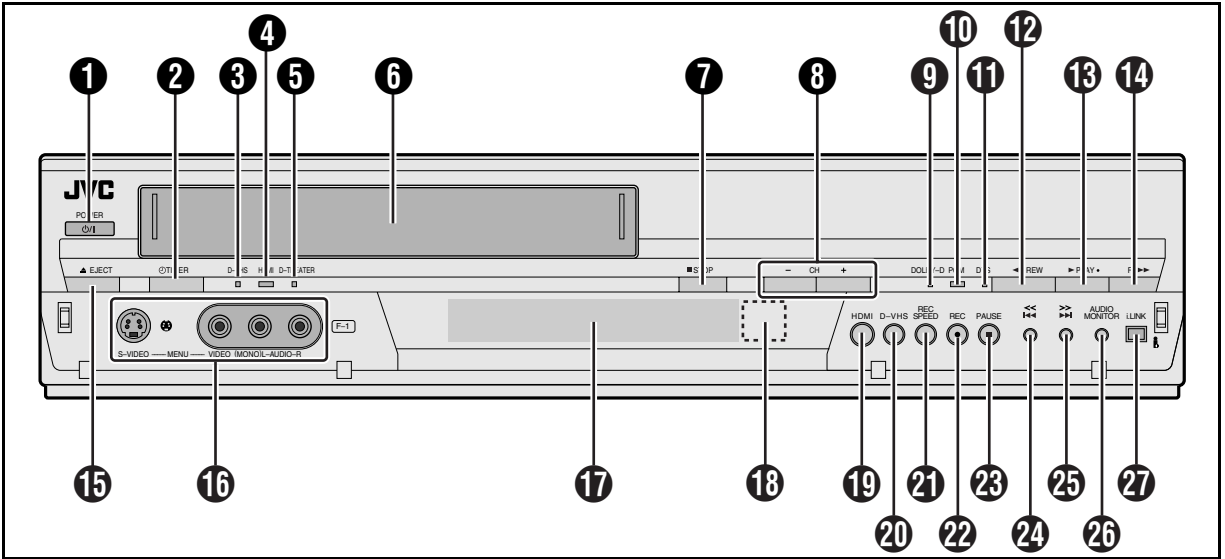

- 1 [POWER] button : page 28, 36
- 2 [TIMER] button : page 41, 45, 46
- 3 [D-VHS] LED : page 35, 36
- 4 [HDMI] LED : page 12
- 5 [D-THEATER] LED : page 52
- 6 Cassette loading slot
- 7 [STOP] button : page 28, 36
- 8 [CHANNEL +] and [-] buttons : page 30, 35, 36
- 9 [DOLBY-D] LED : page 32
- 10 [PCM] LED : page 32
- 11 [DTS] LED : page 32
- 12 [REW] button : page 28, 33
- 13 [PLAY] button : page 28
- 14 [FF] button : page 28, 33
- 15 [EJECT] button : page 28, 36
- 16 [S-VIDEO]/[VIDEO]/[AUDIO] input connectors [F-1] : page 74
- 17 Front display panel : page 9
- 18 Remote sensor
- 19 [HDMI] button : page 12
- 20 [D-VHS] button : page 36
- 21 [REC SPEED] button : page 35, 36
- 22 [REC] button : page 35, 36
- 23 [PAUSE] button : page 34, 36
- 24 [REVERSE] button : page 31
- 25 [SKIP] button : page 31
- 26 [AUDIO MONITOR] button : page 30
- 27 [i.LINK] connector : page 72

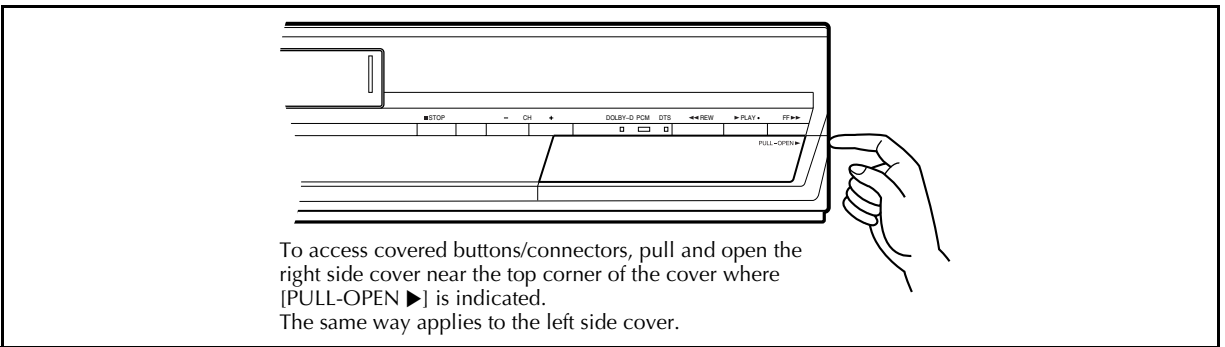

## Rear panel

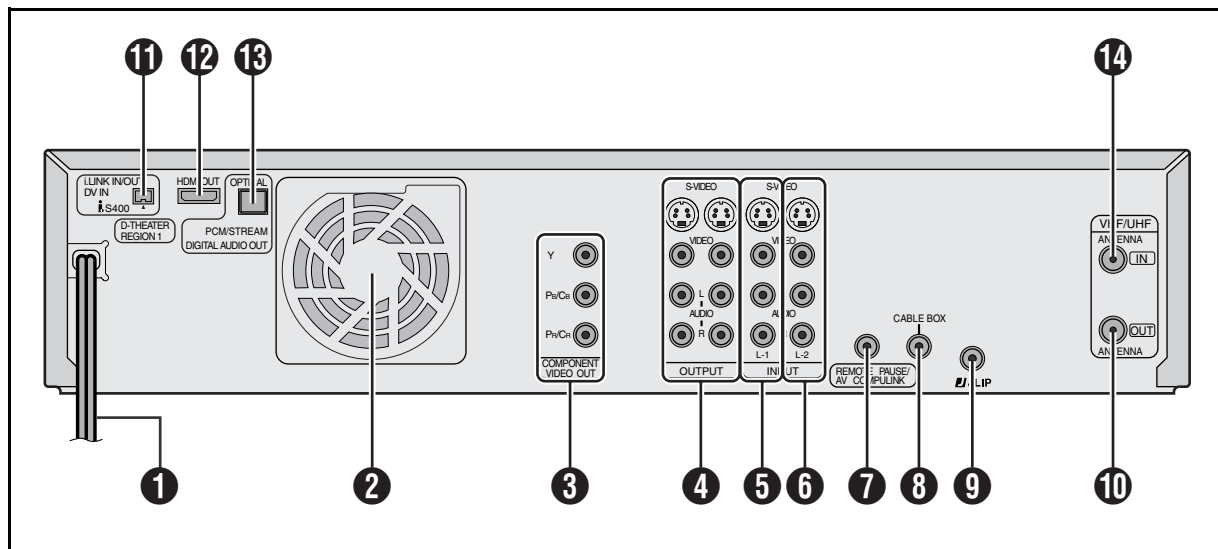

- 1** AC power cord : [page 13](#)
- 2** Cooling fan
- This prevents the temperature from rising inside the VCR. Do not remove it.
  - Install the VCR so as not to block the area around the cooling fan.
  - The cooling fan may be activated even if the unit is turned off in the following case;
    - if the Auto Clock Set and Auto Tuner Set have not been completed automatically by the Plug & Play setting. ([page 16](#))
    - Setting the clock manually ([page 19](#)) will turn off the cooling fan.
- 3** [COMPONENT VIDEO OUT] connectors : [page 13](#)
- 4** [S VIDEO]/[AUDIO]/[VIDEO OUTPUT] connectors : [page 13](#)
- 5** [S VIDEO]/[AUDIO]/[VIDEO INPUT] connectors (L-1) : [page 15, 74](#)
- 6** [S VIDEO]/[AUDIO]/[VIDEO INPUT] connectors (L-2) : [page 15, 74](#)
- 7** [REMOTE PAUSE/AV COMPULINK] terminal
- [REMOTE PAUSE] terminal : [page 75](#)
  - [AV COMPULINK] terminal : [page 67](#)
- 8** [CABLE BOX] Controller connector : [page 22, 25](#)
- 9** [JLIP] terminal : [page 69](#)
- 10** [ANTENNA OUT] terminal : [page 13](#)
- 11** [i.LINK IN/OUT], [DV IN] Connector (i.Link\*) : [page 72](#)
- \* i.Link refers to the IEEE1394-1995 industry specification and extensions thereof. The  logo is used for products compliant with the i.Link standard.
- 12** [HDMI OUT] connector: [page 13, 15](#)
- 13** [OPTICAL] terminal : [page 13, 64](#)
- 14** [ANTENNA IN] terminal : [page 13](#)



## Front display panel

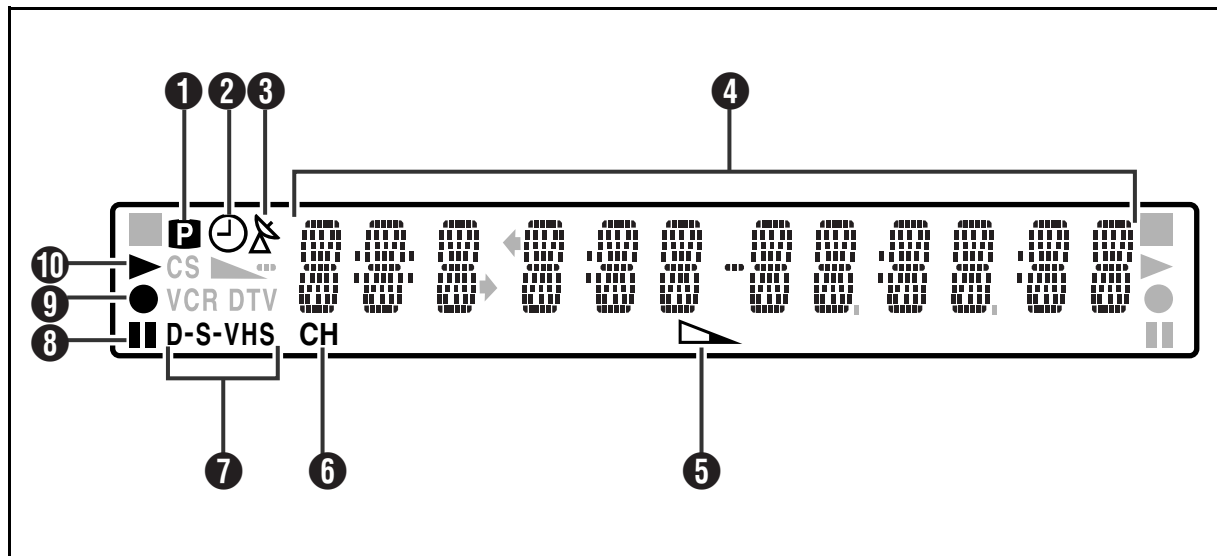

- ❶ Progressive mode indicator : page 14, 65
- ❷ Timer mode indicator : page 41, 45
- ❸ Satellite Auto Recording indicator : page 47
- ❹ Channel/auxiliary input ([L1],[L2],[F1],[I-1] etc.)  
Clock time  
Time counter : page 29  
Remaining time  
Recording mode indicator : page 37, 41  
Tape speed

- ❺ Remain indicator : page 37
- ❻ Channel mode indicator
- ❼ Cassette type indicator : page 35
- ❽ Pause mode indicator : page 34, 36
- ❾ Record mode indicator : page 37, 41
- ❿ Play mode indicator : page 29, 41

# On-screen display

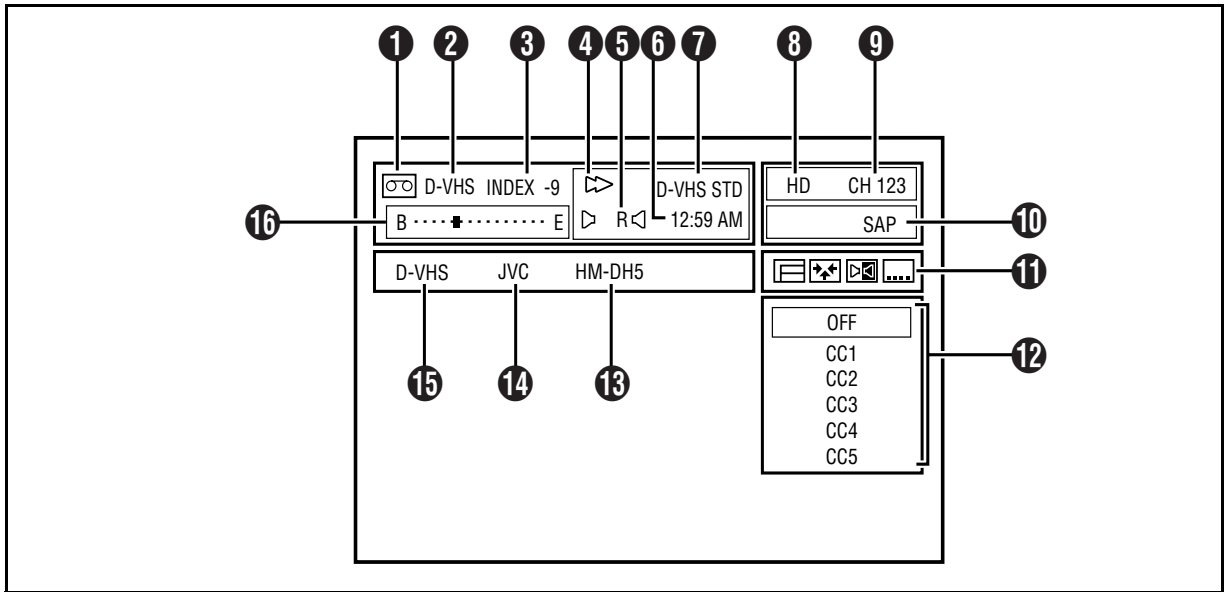

- ❶ Cassette indication
- ❷ Cassette type indication : page 35
- ❸ Index no. indication : page 31
- ❹ VCR operation mode indication
- ❺ Audio monitor indications : page 30
- ❻ Clock time  
Time counter\*  
Tape remaining time (When “REMAIN” appears)\*\*  
\* To reset the time counter, press [C.RESET] on the Remote. The counter reading becomes “0:00:00”. It is also reset when a tape is inserted.  
\*\* The tape remaining time is calculated based on the recording speed being used. The indicated remaining time is only an estimate.
- ❼ Recording mode indication : page 35, 36  
Recording speed indication
- ❽ Image format (“HD”/“SD”)
- ❾ Auxiliary input (“L-1”, “L-2”, “F-1” and “I-1” etc.)
- ❿ Audio Indications

“STEREO”	When receiving the stereo broadcast
“Dolby D”	When playing back and receiving Dolby Digital signals
“STREAM”	When playing back and receiving audio signals in other new formats
“PCM”	When playing back and receiving PCM audio signals
“AUDIO 1” “AUDIO 2” “1+2 MIX”	Depends on the “DV AUDIO REC” setting ( page 64)

- ⓫ Icons : page 32
  - : appears when a D-VHS cassette contains the multiple programs
  - : appears when a D-VHS cassette contains the multiple angle
  - : appears when a D-VHS cassette contains the audio in multiple language
  - : appears when a D-VHS cassette contains the subtitle in multiple language

**NOTE:**  
The subtitles does not appear while the on-screen display is displayed.

- ⓬ Selections of the selected icon (❿)
- ⓭ Model name of the device connected to the i.LINK connector
- ⓮ Brand name of the device connected to the i.LINK connector
- ⓯ Type of device connected to the i.LINK connector
- ⓰ Tape position indicator : page 29

## Remote

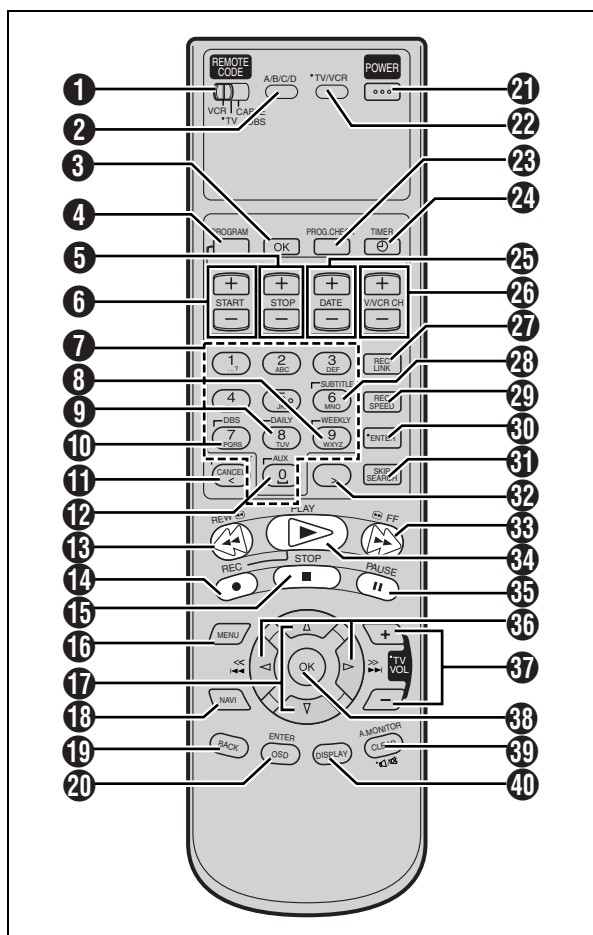

### How to use the Remote

Before use, insert two AA size batteries into the Remote with the polarity (+ and -) matched correctly as indicated on the battery compartment or on the lid.

The Remote can operate most of your VCR's functions, as well as basic functions of TV sets, cable boxes and DBS receivers.

- Point the Remote toward the remote sensor on the target component.
- The maximum operating distance of the remote control is about 8 m (26ft.).

### NOTES:

- If the Remote does not work properly, remove its batteries, wait for a few seconds, replace the batteries and then try again.
- If the batteries of the Remote are weak, the Remote will not be able to control the TV, cable box or DBS receiver. Replace the batteries.

- 1 [VCR/TV/CABLE/DBS] selector : page 76 - 78
- 2 [A/B/C/D] button : page 78
- 3 [OK] button
- 4 [PROGRAM] button : page 40, 44
- 5 [STOP +/-] buttons : page 41, 44
- 6 [START +/-] buttons : page 41, 44
- 7 Number keys : page 36, 76  
Character input buttons : page 58
- 8 [WEEKLY] button : page 41, 45, 46
- 9 [DAILY] button : page 41, 45, 46
- 10 [DBS] button : page 45
- 11 [CANCEL] button : page 40, 46  
[C. (Counter) RESET] button : page 29  
[<] button : page 51
- 12 [AUX] button : page 49, 75
- 13 [REW (◀◀)] button : page 28, 33
- 14 [REC (●)] button : page 35, 36
- 15 [STOP (■)] button : page 28, 36
- 16 [MENU] button : page 17
- 17 [Δ∇] buttons : page 17, 18
- 18 [NAVI] button : page 51
- 19 [BACK] button : page 41, 62
- 20 [OSD] button : page 38  
[ENTER] button
- 21 [POWER] button : page 28, 36
- 22 [TV/VCR] button : page 76
- 23 [PROG. CHECK] button : page 46
- 24 [TIMER ⌚] button : page 41, 45, 46
- 25 [DATE +/-] buttons : page 41, 44
- 26 [TV/VCR CH +/-] buttons : page 30, 35, 44, 76, 77
- 27 [REC LINK] button : page 47
- 28 [SUBTITLE] button : page 32
- 29 [REC SPEED] button : page 35, 36
- 30 [ENTER] button : page 76, 77
- 31 [SKIP SEARCH] button: page 31
- 32 [>] button : page 51
- 33 [FF (▶▶)] button : page 28, 33
- 34 [PLAY (▶)] button : page 28, 35
- 35 [PAUSE (||)] button : page 34, 36
- 36 [◀◀▶▶] (◁▷) buttons : page 17, 31
- 37 [TV VOL +/-] buttons : page 76
- 38 [OK] button
- 39 [A. (Audio) MONITOR] button : page 30  
[CLEAR] button : page 58  
[MUTE] (TV Muting) button : page 76
- 40 [DISPLAY] button : page 37

The glow-in-the-dark buttons shown in white on the illustration on the left column are helpful when using the Remote in darkened rooms.

Buttons with a small dot on the left side of the name can also be used to operate your TV after setting the [VCR/TV/CABLE/DBS] selector to [TV]. (page 76)

# Connections

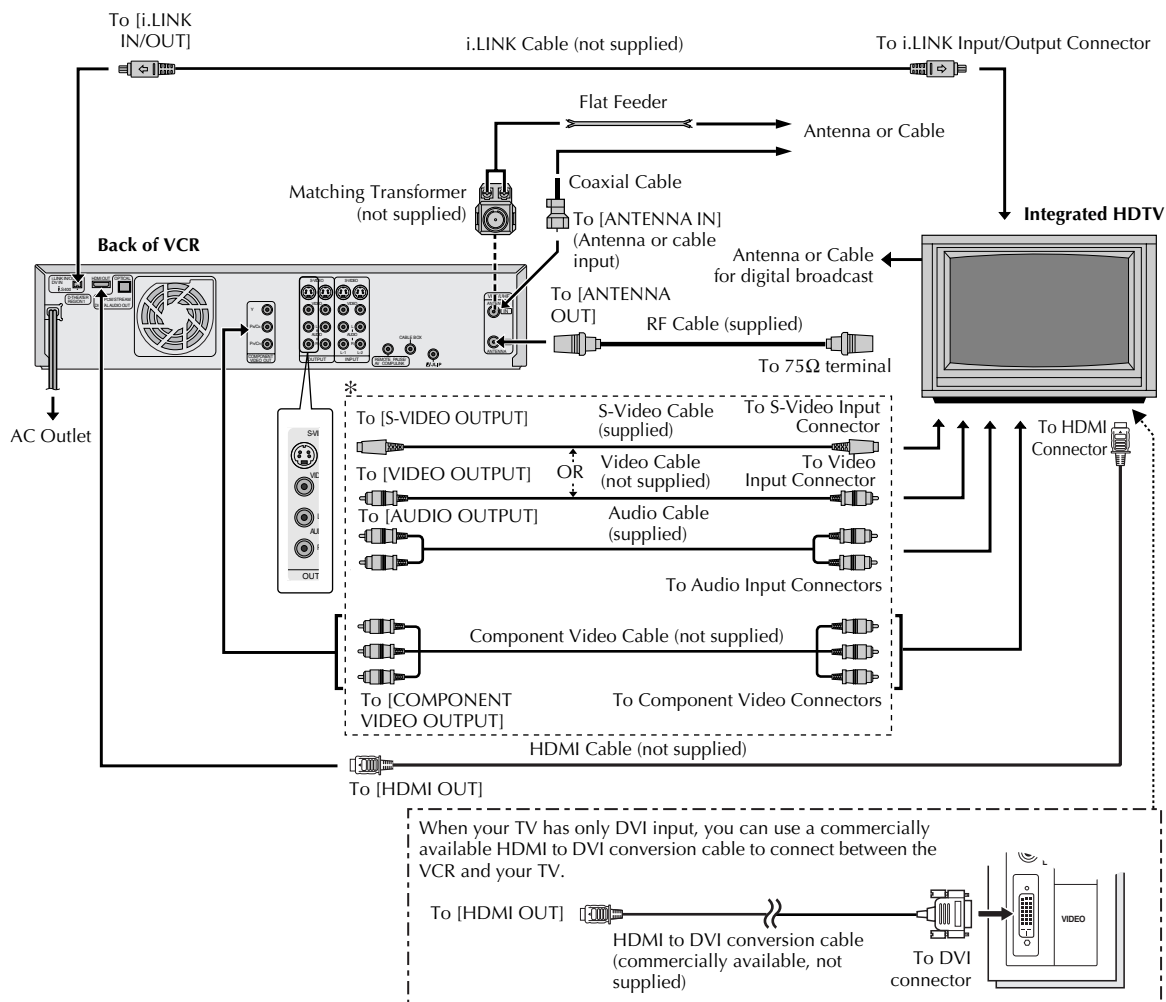

## NOTES:

- HDMI will be automatically activated (HDMI-ON) when a HDMI connection has been made. To de-activate (HDMI-OFF), press [HDMI] on the front panel and the [HDMI] LED will turn off. During HDMI-ON ([HDMI] LED on), the image format output to the TV connected via the HDMI connector will be in accordance to the image format of the TV. During HDMI-OFF ([HDMI] LED off), the image format output to the TV is in accordance to this VCR's "IN/OUT FUNCTION" menu settings "TV OUTPUT 1" and "TV OUTPUT 2" (☞ page 65). If the picture cannot be properly displayed on the TV when using the HDMI to DVI connection, try setting HDMI to OFF. If your TV is not High-Bandwidth Digital Content Protection (HDCP) compatible, the pictures will not be properly displayed on the TV. In this case, use the component video, s-video or video connection.
- If you cannot see the pictures on the TV screen when you play back a tape, set "TV OUTPUT 2" to the appropriate mode (☞ page 65). "TV OUTPUT 2" is invalid when HDMI is activated.
- To operate the VCR with your TV using the HDMI, DVI, Component Video or S-VIDEO connection, set your TV to the AV mode using the TV's Remote. You can also use the TV/VCR button on the VCR's Remote to set your TV to the AV mode (☞ page 76).
- To ensure that you can record one show while watching another (☞ page 38), you must also connect the VCR to the TV using the RF cable.
- Use the commercially available i.LINK cable (4-pin, S400, below 3m). If the cable used is above 3m, this VCR will not fully maximize its performance.
- For full identification of the VCR's rear panel, refer to the Index (☞ page 8).

## Basic Connection

### 1 Check contents

Make sure the package contains all of the accessories listed in 'SPECIFICATIONS' (☞ page 89).

### 2 Situate VCR

Place the VCR on a stable, horizontal surface.

### 3 Connect VCR to TV

The following connections are required.

- ① Disconnect the TV antenna from the TV.
- ② Connect the TV antenna cable to the VCR's [ANTENNA IN] terminal.
- ③ Connect the supplied RF cable between the VCR's [ANTENNA OUT] terminal and the TV's antenna input terminal.
- ④ Connect a HDMI cable between the VCR's [HDMI OUT] connector and the TV's HDMI input connector.  
If your TV has only DVI input, use a HDMI to DVI conversion cable to connect to the VCR's [HDMI OUT] connector. Also, connect an audio cable between the VCR's [AUDIO OUTPUT] connectors and the TV's audio input connectors. If your TV is connected to an AV Amplifier, you can make use of the VCR's [OPTICAL] connector to connect to the amplifier (☞ page 64).
- ⑤ Connect an i.LINK cable between the VCR's [i.LINK IN/OUT] connector and the TV's i.LINK input/output connector.

**\* If your TV does not have a HDMI or DVI connector, you can make a 'Component Video Connection' or 'VIDEO/S-VIDEO Connection' as stated below:**

#### Component Video Connection

- a- Connect a component video cable between the VCR's [COMPONENT VIDEO OUT] connectors and the TV's component video input connectors.
- b- Connect an audio cable between the VCR's [AUDIO OUTPUT] connectors and the TV's audio input connectors.

#### VIDEO/S-VIDEO Connection

- a- Connect an S-Video cable between the VCR's [S-VIDEO OUTPUT] connector and the TV's S-Video input connector.  
If your TV does not have a S-Video input connector, use a video cable to connect between the VCR's [VIDEO OUTPUT] connector and the TV's video input connector.
- b- Connect an audio cable between the VCR's [AUDIO OUTPUT] connectors and the TV's audio input connectors.

### 4 Connect VCR to power source

Connect the AC power plug to the AC outlet.

- The clock and tuner channels will automatically be set when the antenna is connected and when the AC power cord is first connected to an AC power outlet (☞ page 16).  
(If [AUTO] or channel numbers are displayed on the front display panel before the VCR is turned on, the clock and tuner channels are being set automatically. Wait until the clock time is displayed on the front display panel before turning on the VCR.)

### 5 Final preparation for use

Turn on the VCR.

- You can now perform basic playback (☞ page 28) or basic recording (☞ page 35).

#### ATTENTION:

*When this VCR is connected to some HDMI devices, signals that are normally output from the VCR in the 480i image format may be outputted as 480p image format signals. In such cases, signal cannot be output from the [S VIDEO OUTPUT] connector or the [VIDEO OUTPUT] connectors. If the [S VIDEO OUTPUT] connector or the [VIDEO OUTPUT] connectors are used, press the [HDMI] button on the front panel to turn off the [HDMI] LED and set "TV OUTPUT 2" to "ALLto480i" (☞ page 65).*

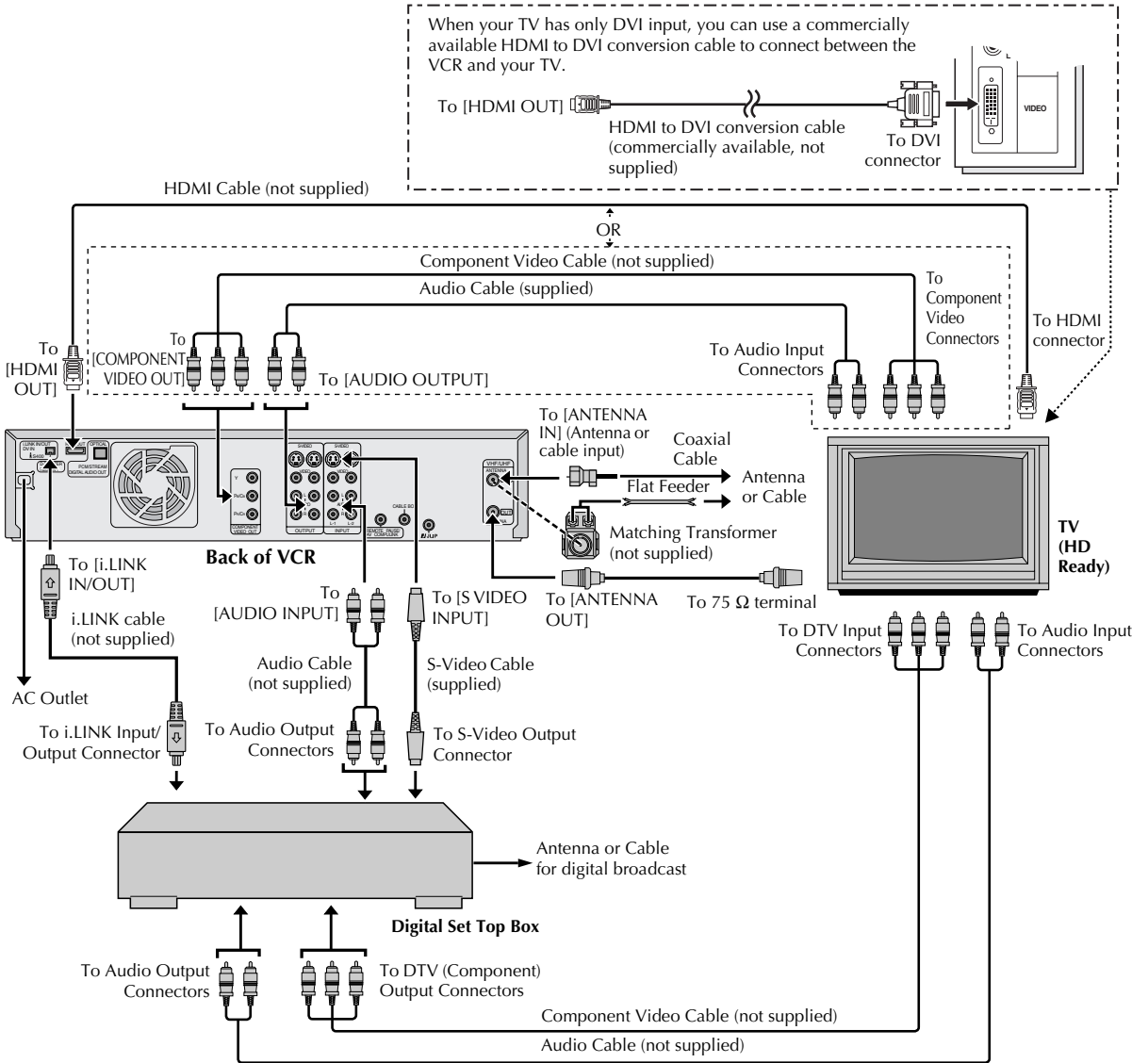

**NOTES:**

- If you have made a component video connection and your TV's component video connectors support only high definition signal format, connect also the S-VIDEO or VIDEO connectors between the VCR and TV in order to view the picture of 480i image format output from the VCR.
- Through the component video connection and if your TV's component video connectors support only the progressive video input and not high definition video input, you can set "TV OUTPUT 2" to "ALLto480p" (page 65) or "480i to 480p" to "ON" (page 65) to enjoy high quality picture. The progressive mode indicator [P] on the front display panel will light up when the video output is in progressive mode.
- Use the commercially available i.LINK cable (4-pin, S400, below 3m). If the cable used is above 3m, this VCR will not fully maximize its performance.
- To connect the antenna for the Digital Set Top Box, refer to the instruction manual for Digital Set Top Box.

## Digital Set Top Box Connection

If you are using a HD Ready TV, you can make use of this connection to connect to the VCR.

First, check the contents and situate the VCR as instructed in steps **1** and **2** on page 13. Then go to the following steps.

### 3 Connect VCR to Digital Set Top Box

- ❶ Connect an i.LINK cable between the VCR's [i.LINK IN/OUT] connector and Digital Set Top Box's i.LINK input/output connector.
- ❷ Connect an audio/S-Video cable between the VCR's [AUDIO/S VIDEO INPUT] connectors and the Digital Set Top Box's audio/S-Video output connectors.

### 4 Connect VCR to TV

#### A HDMI Connection

- ❶ Connect both the RF cable and the AV cables to the TV as explained in step **3** ❶ ~ ❸ of 'Basic Connection' (☞ page 13).
- ❷ Connect a HDMI cable between the VCR's [HDMI OUT] connector and the TV's HDMI input connector.  
If your TV has only DVI input, use a HDMI to DVI conversion cable to connect to the VCR's [HDMI OUT] connector. Also, connect an audio cable between the VCR's [AUDIO OUTPUT] connectors and the TV's audio input connectors. If your TV is connected to an AV amplifier, you can make use of the VCR's [OPTICAL] connector to connect to the amplifier (☞ page 64).

OR

If your TV does not have a HDMI or DVI connector, you can make a 'Component Video Connection' as stated in **B** below, or 'VIDEO/S-VIDEO Connection' as on page 13.

#### B Component Video Connection

- ❶ Connect both the RF cable and the AV cables to the TV as explained in step **3** ❶ ~ ❸ of 'Basic Connection' (☞ page 13).
- ❷ Connect a component video cable between the VCR's [COMPONENT VIDEO OUT] connectors and the TV's component video input connectors.
- ❸ Connect an audio cable between the VCR's [AUDIO OUTPUT] connectors and the TV's audio input connectors.

### 5 Connect Digital Set Top Box to TV

- ❶ Connect a component video cable between the Digital Set Top Box's DTV (component) output connectors and the TV's DTV input connectors.
- ❷ Connect an audio cable between the Digital Set Top Box's audio output connectors and the TV's audio input connectors.

### 6 Connect VCR to power source

Connect the AC power plug to the AC outlet.

- The clock and tuner channels will automatically be set when the antenna is connected and when the AC power cord is first connected to an AC power outlet (☞ page 16).  
(If [AUTO] or channel numbers are displayed on the front display panel before the VCR is turned on, the clock and tuner channels are being set automatically. Wait until the clock time is displayed on the front display panel before turning on the VCR.)

### 7 Final preparation for use

Turn on the VCR.

- You can now perform basic playback (☞ page 28) or basic recording (☞ page 35).

#### ATTENTION:

*When this VCR is connected to some HDMI devices, signals that are normally output from the VCR in the 480i image format may be outputted as 480p image format signals. In such cases, signal cannot be output from the [S VIDEO OUTPUT] connector or the [VIDEO OUTPUT] connectors. If the [S VIDEO OUTPUT] connector or the [VIDEO OUTPUT] connectors are used, press the [HDMI] button on the front panel to turn off the [HDMI] LED and set "TV OUTPUT 2" to "ALLto480i" (☞ page 65).*

# Plug & Play Setting

## Auto Clock Set/Auto Tuner Set

### ATTENTION:

- If you use a cable box, Plug & Play will not function; set the clock and tuner channels separately. (☞ page 17 - 21)
- It takes several minutes for the VCR to complete the Plug & Play setting.
- Do not press any buttons on the front panel or on the Remote while Plug & Play is in progress.

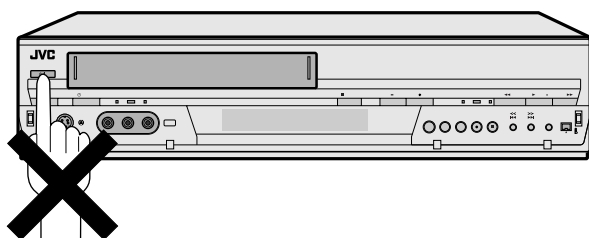

## 1 Perform Plug & Play setup

Connect the antenna cable to the VCR (☞ page 13). Then connect the AC power cord to an AC outlet. Do not turn on the VCR.

The clock and tuner channels will be set automatically.

### NOTES:

- When AC cord is connected to an AC outlet, [LOADING] appears on the front display panel. It takes some time until VCR completes its setup.
- Auto Clock Set is performed first. [AUTO] blinks on the front display panel during Auto Clock Set.
- Auto Channel Set is performed next. Auto Channel Set scans all the channels that are receivable by your VCR. During Auto Channel Set, the channel numbers are displayed as they are scanned and set.
- When Plug & Play setting has been complete successfully, the correct clock time is displayed. If you perform Plug & Play setting successfully, there is no need to perform the clock (☞ page 17) and tuner (☞ page 20) settings. If, however, you want to add or delete channels, refer to Manual Channel Set on page 21.



**During Initial Auto Clock Set**  
[AUTO] blinks.



**During Auto Channel Set**  
The channel numbers are displayed as they are scanned and set.



**Plug & Play Completed**  
The current time is displayed. ([PM] lights up during the afternoon.)

\* If an incorrect clock time or [- :-] appears on the display panel, see 'What to do if Plug & Play setting failed' below.

### INFORMATION

- If "AUTO CLOCK" is set to "ON" on the Clock Set screen on page 17, the clock will be adjusted automatically by the host channel every hour (except 11:00 PM, midnight, 1:00 AM and 2:00 AM) using the incoming PBS channel clock setting data. (This automatic clock adjustment can only be performed when the VCR is turned off. The clock will be adjusted just on these hours — on the time displayed on the front display panel, not on the actual real time.) The default setting of "AUTO CLOCK" is "ON".
- If the memory backup fails, because a power outage occurs or because the AC power cord is unplugged, Auto Clock Set will be performed when power is restored to the VCR.
- Poor antenna or cable signal may prevent the VCR from receiving the Auto clock setting data from a PBS channel. If this function is taking a considerable amount of time, it may be necessary to perform the Semiauto (☞ page 18) or Manual Clock Set (☞ page 19) procedure.

### What to do if Plug & Play setting failed

- If an incorrect time is displayed on the front display panel, you may be receiving the clock setting data of a PBS channel from an adjacent time zone, or an incorrect PBS channel from a cable TV system. In this case, perform the Semiauto (☞ page 18) or Manual Clock Set (☞ page 19) procedure.
- If [- :-] appears on the front display panel, your antenna cable may not be connected to the VCR or there may not be a Host PBS signal available in your area. Ensure that the antenna cable is connected correctly. Then turn on and off the VCR; the Plug & Play setting will be automatically reactivated. If Plug & Play setting is not performed though the antenna cable is connected correctly, perform Manual Clock Set (☞ page 19) and Auto Channel Set or Manual Channel Set (☞ page 20 or 21).



# Clock Setting

- Turn on the VCR and the TV, and select the AV mode on the TV.
- Set the [VCR/TV/CABLE/DBS] selector on the Remote to [VCR].

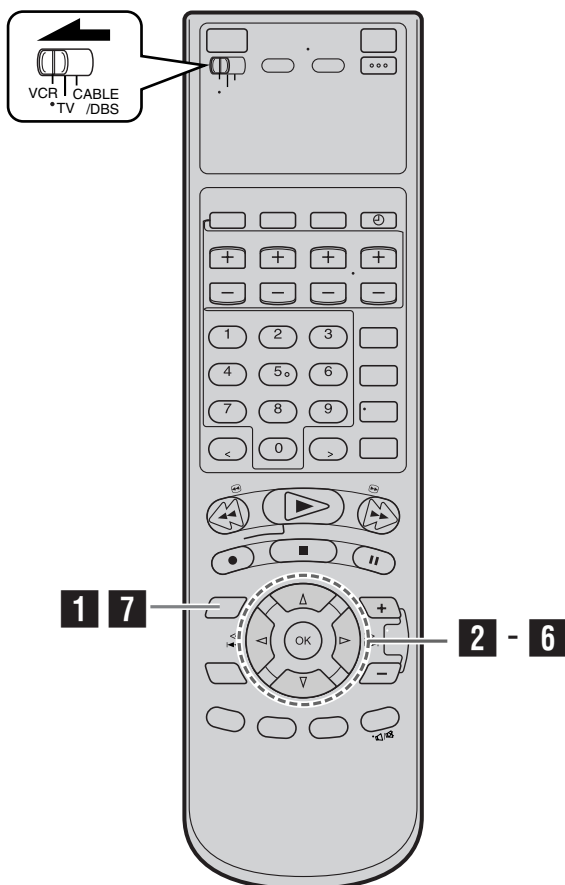

Perform clock setting only if the clock has not been set correctly by the Plug & Play setting or if you use a cable box.

Access the Clock Set screen to perform the Semiauto or Manual Clock Set. Each procedure starts from step **3** after preparation steps below are finished.

If you use a cable box, set the clock manually. (page 19)

## Preparations

### 1 Access Main Menu screen

Press [MENU].

### 2 Access Clock Set screen

- 1 Press [◀ ▶] to move the arrow to "INITIAL SET UP", then press [▽] or [OK].
- 2 Press [◀ ▶] to move the arrow to "CLOCK SET", then press [▽] or [OK].

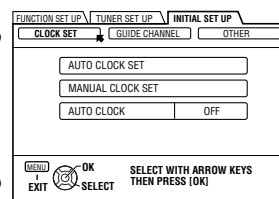

- If "CABLE BOX USERS SET CLOCK MANUALLY" appears on the screen, press [OK] to access the Clock Set screen. (Even if you do not press [OK], the Clock Set screen disappears after 5 seconds, then the Clock Set screen appears automatically.)

## Setting clock semiautomatically

### — Semiauto Clock Set

You can change the host channel/D.S.T./time zone setting manually.

First follow steps **1** to **2** on page 17, then go to the following steps.

### 3 Access Auto Clock Set screen

Press [Δ∇] to move the arrow to "AUTO CLOCK SET", then press [OK].

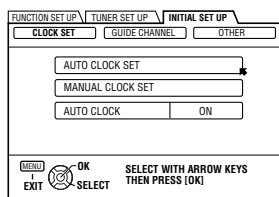

Then;  
To select the host channel — go to step **4**.  
To select the D.S.T. mode — go to step **5**.  
To select the time zone — go to step **6**.

#### NOTE:

The time set previously will be erased when "AUTO CLOCK SET" is selected.

### 4 Select host channel

You can either select "AUTO" or enter a PBS channel number. Press [Δ∇] to move the arrow to "HOST CH", then press [◀ ▶] until "AUTO" or the desired PBS channel number is selected.

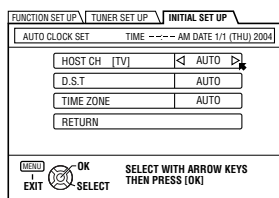

#### NOTE:

Some PBS channels do not transmit clock setting data.

#### \* Auto Daylight Saving Time

This function enables automatic adjustment of the VCR's clock at the start and end of Daylight Saving Time.

With Auto DST activated, . . .

. . . on the first Sunday of April at 2:00 AM, the clock is adjusted to 3:00 AM.

. . . on the last Sunday of October at 2:00 AM, the clock is adjusted to 1:00 AM.

### 5 Select D.S.T. mode

You have three choices:

"AUTO"— Select if you want to adjust your VCR's clock automatically by the incoming signal from the host channel. (Auto Daylight Saving Time\*)

"ON"— Adjustment will be made by the built-in clock itself.

"OFF"— Select when Daylight Saving Time does not apply to you.

Press [Δ∇] to move the arrow to "D.S.T.", then press [◀ ▶] repeatedly until the desired setting is selected.

### 6 Select time zone

Press [Δ∇] to move the arrow to "TIME ZONE", press [◀ ▶] repeatedly until "AUTO" or the desired time zone is selected.

Each time you press the button, the time zone changes as follows:

≡ "AUTO" ≡ "ATLANTIC" ≡ "EASTERN"  
≡ "CENTRAL" ≡ "MOUNTAIN" ≡ "PACIFIC"  
≡ "ALASKA" ≡ "HAWAII" ≡ (back to the beginning)

#### NOTE:

If an incorrect clock time is displayed by the Plug & Play setting, you may be receiving the clock setting data of a PBS channel from an adjacent time zone or from an incorrect PBS channel from a cable TV system. If you selected "AUTO" for the host channel in step **4**, be sure to select the correct time zone manually.

### 7 Return to normal screen

Press [MENU].

#### IMPORTANT:

Turn off the VCR after performing Semiauto Clock Set. [AUTO] will appear on the front display panel while the clock is being set. The current clock time will appear automatically when the clock setting is complete.

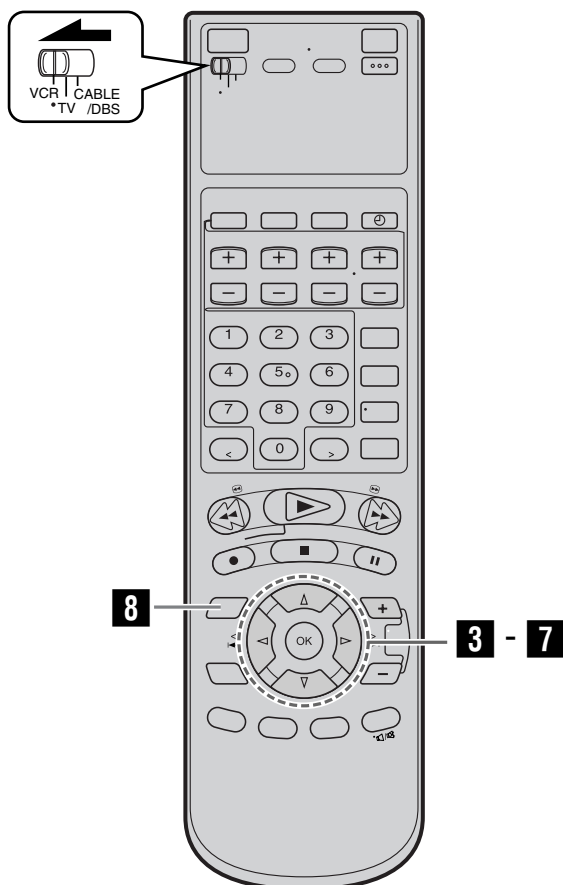

## Setting clock manually

### — Manual Clock Set

First follow steps **1** to **2** on page 17, then go to the following steps.

### 3 Access Manual Clock Set screen

Press [ $\Delta \nabla$ ] to move the arrow to “MANUAL CLOCK SET”, then press [OK].

### 4 Set time

Press [ $\triangleleft$ ] until the desired time appears, then press [ $\nabla$ ].

- Holding [ $\triangleleft$   $\triangleright$ ] changes the time in 30-minute intervals.

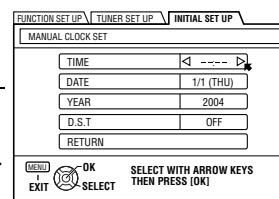

### 5 Set date

Press [ $\triangleleft$   $\triangleright$ ] until the desired date appears, then press [ $\nabla$ ].

- Holding [ $\triangleleft$   $\triangleright$ ] changes the date in 15-day intervals.

### 6 Set year

Press [ $\triangleleft$   $\triangleright$ ] until the desired year appears.

### 7 Select D.S.T. mode

Press [ $\Delta \nabla$ ] to move the highlight bar to “D.S.T.”, then press [ $\triangleleft$   $\triangleright$ ] to select “ON” or “OFF”.

“ON”– Adjustment will be made by the built-in clock itself.

“OFF”– Select when Daylight Saving Time does not apply to you.

### 8 Start clock

Press [MENU] and normal screen appears.

#### To make corrections any time during the process

Press [ $\Delta \nabla$ ] to select the item you want to change, then press [ $\triangleleft$   $\triangleright$ ].

# Tuner Setting

- Turn on the VCR and the TV, and select the AV mode on the TV.
- Set the [VCR/TV/CABLE/DBS] selector on the Remote to [VCR].

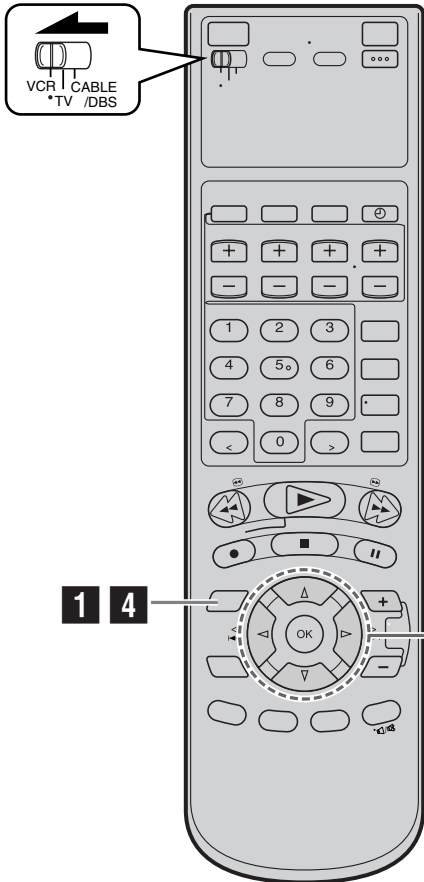

## Setting channels automatically — Auto Channel Set

Use Auto Channel Set only if channels have not been set correctly by the Plug & Play setting. If you want to add or delete channels, use Manual Channel Set (page 21).

### 1 Access Main Menu screen

Press [MENU].

### 2 Access Tuner Set Up screen

- 1 Press [◀ ▶] to move the arrow to "TUNER SET UP", then press [▽] or [OK].
- 2 Press [◀ ▶] to move the arrow to "TUNER SET", then press [▽] or [OK].

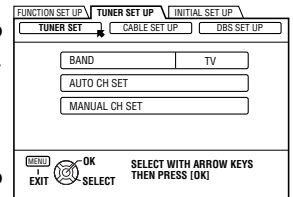

### 3 Perform Auto Channel Set

You can automatically set the receivable channels in your area in the order of their frequencies.

Press [△▽] to move the arrow to "AUTO CH SET", then press [OK].

#### NOTES:

- When Auto Channel Set is complete, "SCAN COMPLETED" appears on screen.
- If the scan was unsuccessful, "SCAN COMPLETED - NO SIGNAL FOUND -" appears on screen. Check the connections, then select "RETRY" to start again, or select "EXIT".

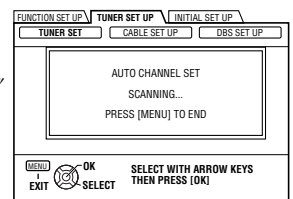
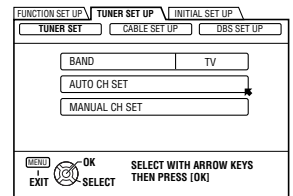

### 4 Return to normal screen

Press [MENU].

#### INFORMATION

The VCR selects the correct band (TV or CATV) automatically during Auto Channel Set. The selected band will be displayed on the right side of "BAND" on the Tuner Set Up screen.

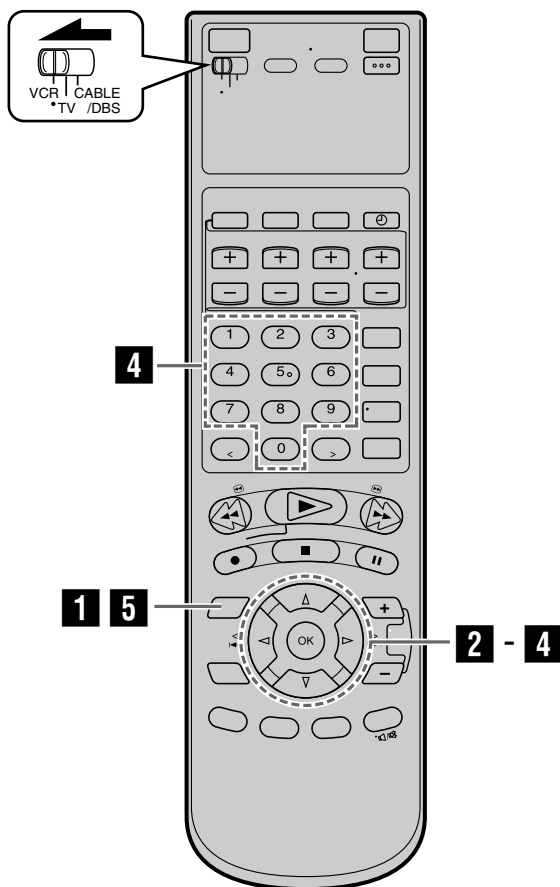

## Setting channels manually

### — Manual Channel Set

You can add the channels you want or delete the channels you do not want manually.

#### 1 Access Main Menu screen

Press [MENU].

#### 2 Access Tuner Set Up screen

1 Press [◀ ▶] to move the arrow to “TUNER SET UP”, then press [▽] or [OK].

2 Press [◀ ▶] to move the arrow to “TUNER SET”, then press [▽] or [OK].

#### 3 Access Manual Channel Set screen

Press [△▽] to move the arrow to “MANUAL CH SET”, then press [OK].

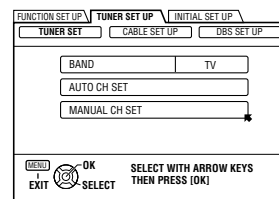

#### 4 Add or skip desired channels

**To add channels**

1 Press [△▽] to move the arrow to “CH”, then press the ‘Number’ keys to input a channel number you want to add.

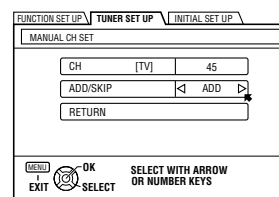

2 Press [△▽] to move the arrow to “ADD/SKIP”, then press [◀ ▶] to set to “ADD”.

3 Repeat 1 and 2 to add other channels.

**To skip channels**

1 Press [△▽] to move the arrow to “CH”, then press the ‘Number’ keys or [◀ ▶] to input a channel number you want to skip.

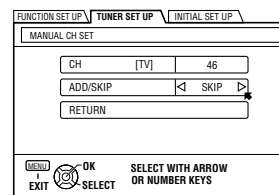

2 Press [△▽] to move the arrow to “ADD/SKIP”, then press [◀ ▶] to set to “SKIP”.

3 Repeat 1 and 2 to skip other channels.

#### 5 Return to normal screen

Press [MENU].

# Cable Box Control Setting

## Suggested location

Place the cable box on top of the VCR. Attach the VCR's Controller to the top of the VCR with the Controller's transmitter pointed towards the cable box's remote sensor.

### ATTENTION:

The Controller can also control a DBS receiver. If both a cable box and a DBS receiver are used, position the Controller so its signal reaches the remote sensors on both the cable box and DBS receiver.

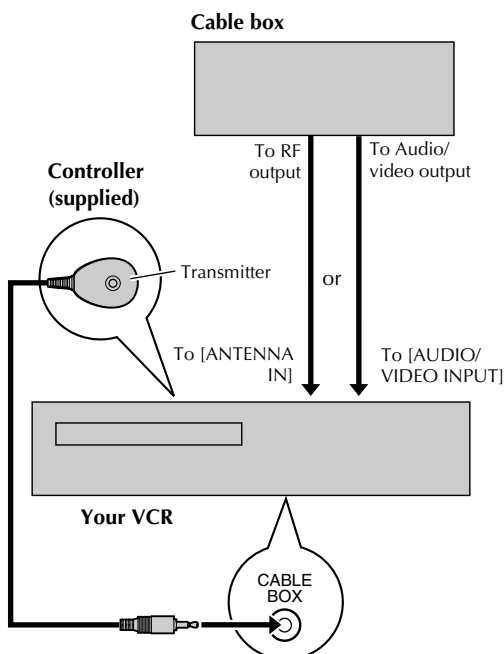
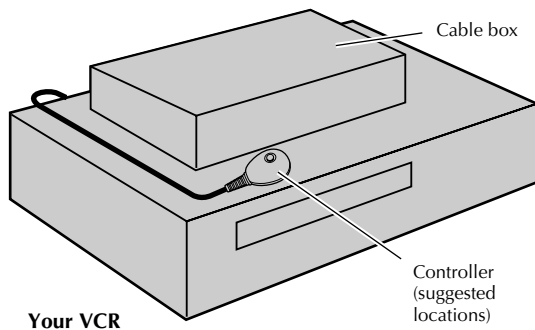

The following procedure is required if you receive your TV channels through a cable box (descrambler). The Controller allows the VCR to automatically switch the cable box channel during timer recording. The Controller is effective for recording broadcasts that have been programmed using VCR Plus+ (☞ page 40) or Express timer programming (☞ page 44).

## Installing Controller

### 1 Situate Controller

Place the Controller so that its transmitter is facing the cable box's remote sensor.

- Make sure the path between the Controller and the cable box's remote sensor is not blocked.

### 2 Attach Controller

Fix securely using the adhesive strip attached on the back of the Controller.

### 3 Connect cable box to VCR

- **If your cable box does not have audio/video output connectors**

Connect the RF output terminal on the cable box to the [ANTENNA IN] terminal on the rear of the VCR.

- **If your cable box has audio/video output connectors**

Connect an audio/video cable between the [AUDIO/VIDEO INPUT] connectors on the rear of the VCR and the audio/video output connectors on the cable box.

### NOTE:

When connecting your cable box, refer to its instruction manual.

### 4 Connect Controller to VCR

Connect the Controller to the CABLE BOX Controller connector on the rear panel.

#### How to control the cable box

This VCR has two separate methods to control your cable box.

- The VCR's wireless Remote can control your cable box. This eliminates the need for a separate cable box's Remote.
- The VCR's Controller can also control your cable box. This allows the VCR to change your cable box's channel number during timer recording.

Each method must be set up separately. To set up the VCR's Remote, refer to page 77. To set up the Controller, go to page 23.

- Turn on the VCR and the TV, and select the AV mode on the TV.
- Set the [VCR/TV/CABLE/DBS] selector on the Remote to [VCR].

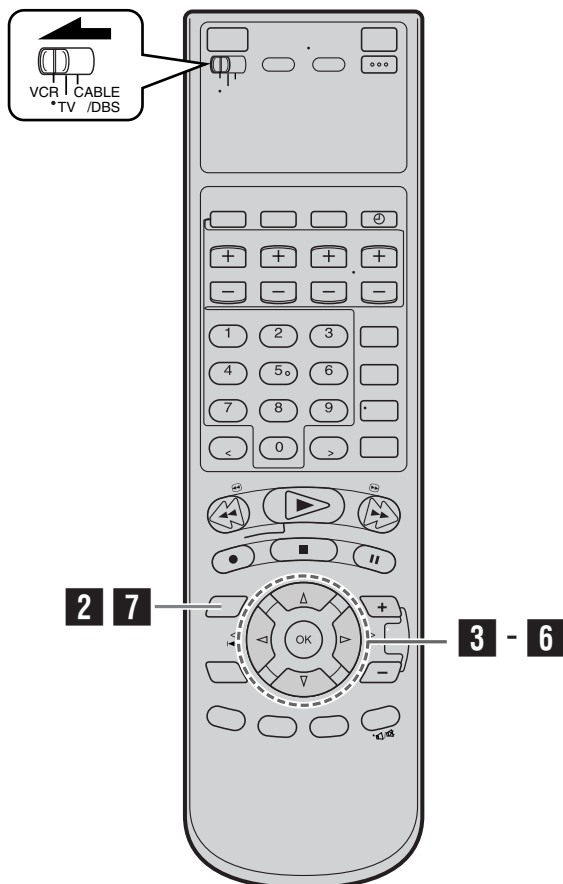

## Setting cable box input channel & brand

After installation, set the cable box input channel and its brand correctly; otherwise, the Controller cannot work correctly.

### 1 Turn on cable box

Select a channel other than channel 9 on your cable box.

### 2 Access Main Menu screen on VCR

Press [MENU].

### 3 Access Cable Set Up screen

- 1 Press [◀ ▶] to move the arrow to "TUNER SET UP", then press [▽] or [OK].

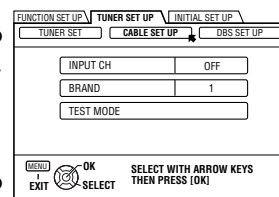

- 2 Press [◀ ▶] to move the arrow to "CABLE SET UP", then press [▽] or [OK].

### 4 Select cable box input channel

Press [△▽] to move the arrow to "INPUT CH".

Your selection depends on how your cable box is connected to your VCR.

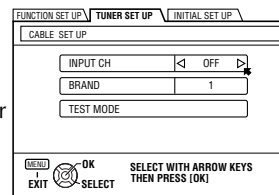

- **If your cable box is connected to your VCR's [ANTENNA IN] terminal on the rear panel**  
Press [◀ ▶] until the channel number representing the cable box's output ("ON CH2 - ON CH9") appears on the screen.
- **If your cable box is connected to your VCR's [AUDIO/VIDEO] input connectors on the front panel**  
Press [◀ ▶] until "ON F-1" appears on the screen.
- **If your cable box is connected to your VCR's [AUDIO/VIDEO INPUT (L-1)] or [AUDIO/VIDEO INPUT (L-2)] connectors on the rear panel**  
Press [◀ ▶] until "ON L-1" or "ON L-2" appears on the screen.
- **If you do not use a cable box**  
Press [◀ ▶] until "OFF" appears on the screen.

## 5 Enter cable box brand

Press  $\Delta \nabla$  to move the arrow to "BRAND".

Press  $\leftarrow \rightarrow$  to enter the brand code from the list shown to the right.

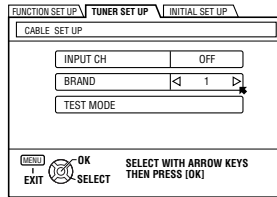

## 6 Engage test mode

Press  $\Delta \nabla$  to move the arrow to "TEST MODE", then press [OK].

### NOTE:

If you do not engage the test mode in step 6, "INPUT CH" and "BRAND" are not set.

### • If the cable box's channel changes to 9, setting is complete

Press  $\leftarrow \rightarrow$  to move the arrow to "YES", then press [OK] and "CABLE BOX CONTROL IS ON" appears on the screen for about 5 seconds.

### • If the cable box's channel does not change to 9

- ① Press  $\leftarrow \rightarrow$  to move the arrow to "NO".
- ② Press [OK].
- ③ Repeat step 5 until the cable box's channel changes to 9 by entering another code.
- ④ If the channel does not change after going through all the code numbers listed for your model of cable box, then try all the other numbers.

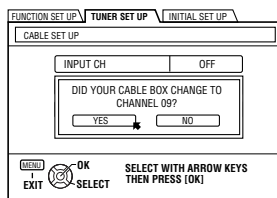

## 7 Return to normal screen

Press [MENU].

### If the VCR's clock has not been set (with "AUTO CLOCK" set to "ON")

"CABLE BOX USERS SET CLOCK MANUALLY" appears for about 5 seconds when you press [OK] in step 3, then the Clock Set screen appears. Perform Manual Clock Set on page 19. If you press [MENU] after the clock has been set, the Cable Box Input Channel screen in step 4 appears.

## CABLE BOX BRAND LIST

BRAND	CODE
ARCHER	1, 5, 17
CABLETENNA	1, 17
CABLEVIEW	15, 16, 17, 21, 25
CITIZEN	15, 16, 17, 21, 25
CURTIS	2, 8
DIAMOND	1, 17
GC BRAND	15, 16, 17, 21, 25
GEMINI	15
GENERAL INSTRUMENTS	1, 4, 6, 11, 12, 15, 28
HAMLIN	10, 18, 23
JASCO	15
JERROLD	1, 4, 6, 11, 12, 15, 28
NOVAVISION	2, 8
OAK	7, 20
PANASONIC	13, 14
PULSER	15, 16, 17, 21, 25
RCA	13, 14
REGAL	10, 18, 23
REMBRANDT	T1, 16, 17
SAMSUNG	5, 16, 24
SCIENTIFIC ATLANTA	2, 8
SIGMA	7, 20
SL MARX	5, 16, 17, 24, 25
SPRUCER	13, 14
STARGATE	5, 15, 16, 17, 21, 24, 25
TELEVIEW	5, 16, 24
TOCOM	1, 4, 16
UNIKA	1, 17
UNIVERSAL	16, 17, 25
VIDEOWAY	3, 9, 22
ZENITH	3, 9, 22

### NOTES:

- The Controller may not work with all types of cable box.
- If your cable box does not respond to any code, you cannot use the Controller to change cable box channels. In this case, make sure to leave the cable box turned on and tuned to the proper channel before the scheduled start time of timer recording.  
Contact your cable company about the possibility of exchanging your current cable box with the one compatible with your VCR.
- The VCR can only change the cable box channel through the Controller during timer recording.
- If your cable box cannot be operated with a Remote (because it has no remote sensor), you cannot use the Controller to change its channels. Make sure to leave the cable box turned on and tuned to the proper channel before the scheduled start time of timer recording.
- If the VCR's memory backup expires because of a power failure, set the cable box input channel and brand again.
- **For customers in U.S.A.:** If you are unable to set the Controller, contact JVC toll free at 1-800-252-5722.



# DBS Receiver Control Setting

## Suggested location

Place the DBS (Direct Broadcast Satellite) receiver on top of the VCR. Attach the VCR's Controller to the top of the VCR with the Controller's transmitter pointed towards the DBS receiver's remote sensor.

### ATTENTION:

The Controller can also control a cable box. If both a DBS receiver and a cable box are used, position the Controller so its signal reaches the remote sensors on both the DBS receiver and cable box.

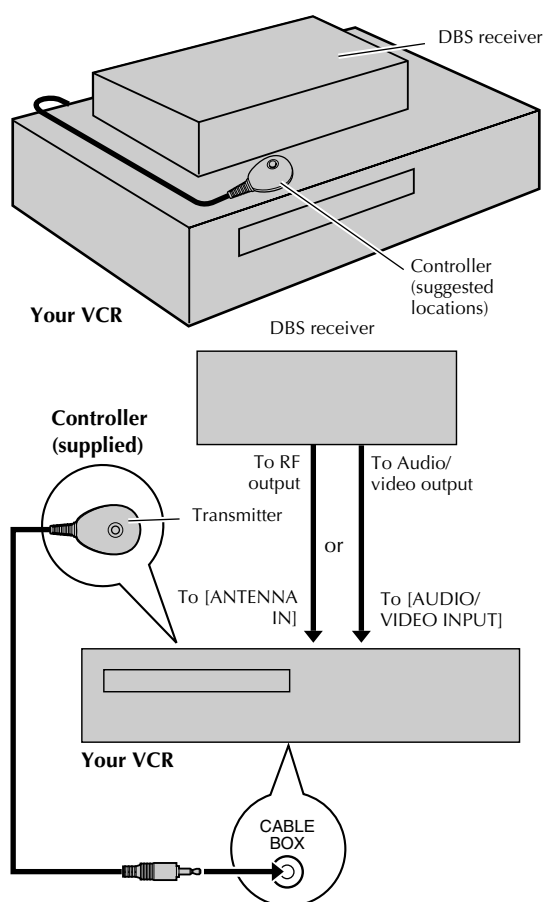

The following procedure is required if you receive satellite channels through a DBS (Direct Broadcast Satellite) receiver. The Controller allows the VCR to automatically switch the DBS receiver's channels during timer recording.

### NOTES:

- The VCR can automatically change the DBS receiver channels using the Controller when the VCR has been programmed using Express timer programming (page 44). Because satellite programming does not use PlusCode, the Controller cannot change the DBS receiver channels during VCR Plus+ timer recording. (You can also use 'Satellite Auto Recording' (page 47) if your DBS receiver is equipped with a timer.)
- If a cable box is also used, it is recommended that you connect the DBS receiver to your VCR's [AUDIO/VIDEO INPUT] connectors and the cable box to your VCR's [ANTENNA IN] terminal.

## Installing Controller

### 1 Situate Controller

Place the Controller so that its transmitter is facing the DBS receiver's remote sensor.

- Make sure the path between the Controller and the DBS receiver's remote sensor is not blocked.

### 2 Attach Controller

Fix securely using the adhesive strip attached on the back of the Controller.

### 3 Connect DBS receiver to VCR

- **If your DBS receiver does not have audio/video output connectors**  
Connect the RF output terminal on the DBS receiver to the [ANTENNA IN] terminal on the rear of your VCR.
- **If your DBS receiver has audio/video output connectors**  
Connect an audio/video cable between the [AUDIO/VIDEO INPUT] connectors on the rear of the VCR and the audio/video output connectors on the DBS receiver.

### NOTE:

When connecting your DBS receiver, refer to its instruction manual.

### 4 Connect Controller to VCR

Connect the Controller to the CABLE BOX Controller connector on the rear panel.

### How to control the DBS receiver

This VCR has two separate methods to control your DBS receiver.

- The VCR's wireless Remote can control your DBS receiver. This eliminates the need for a separate DBS receiver's Remote.
- The VCR's Controller can also control your DBS receiver. This allows the VCR to change your DBS receiver's channel number during timer-recording.

Each method must be set up separately. To set up the VCR's Remote, refer to page 77. To set up the Controller, go to page 26.

- Turn on the VCR and the TV, and select the AV mode on the TV.
- Set the [VCR/TV/CABLE/DBS] selector on the Remote to [VCR].

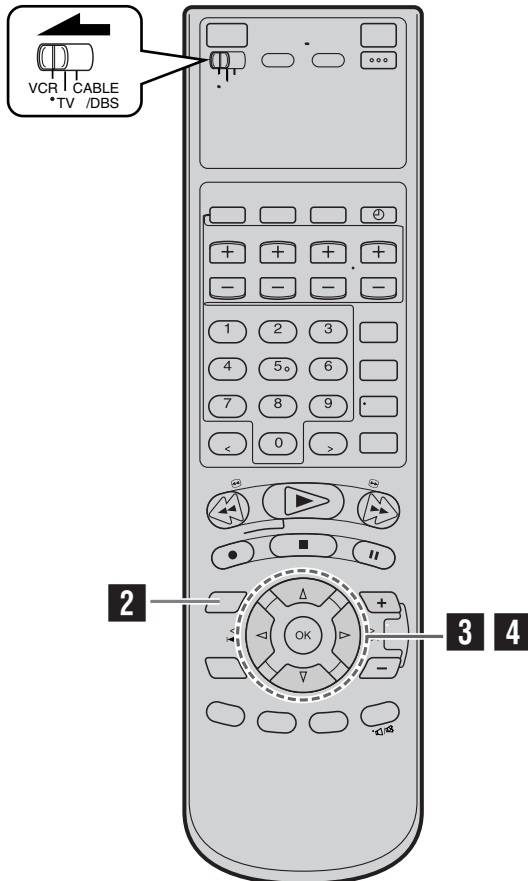

## Setting DBS receiver input channel & brand

After installation, set the DBS receiver's input channel and its brand correctly; otherwise, the Controller cannot work correctly.

### 1 Turn on DBS receiver

Select a channel other than channel 100 or 205 on your DBS receiver.

### 2 Access Main Menu screen on VCR

Press [MENU].

### 3 Access DBS Receiver Set screen

- 1 Press [◀ ▶] to move the arrow to "TUNER SET UP", then press [▽] or [OK].
- 2 Press [◀ ▶] to move the arrow to "DBS SET UP", then press [▽] or [OK].

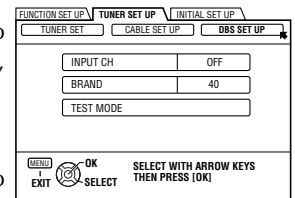

### 4 Select DBS receiver input channel

Press [△▽] to move the arrow to "INPUT CH".

Your selection depends on how your DBS receiver is connected to your VCR.

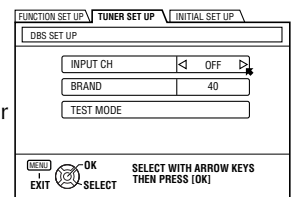

- **If your DBS receiver is connected to your VCR's [ANTENNA IN] terminal on the rear panel**  
Press [◀ ▶] until the channel number representing the DBS receiver's output ("ON CH3" or "ON CH4") appears on the screen.
- **If your DBS receiver is connected to your VCR's [AUDIO/VIDEO] input connectors on the front panel**  
Press [◀ ▶] until "ON F-1" appears on the screen.
- **If your DBS receiver is connected to your VCR's [AUDIO/VIDEO INPUT (L-1)] or [AUDIO/VIDEO INPUT (L-2)] connectors on the rear panel**  
Press [◀ ▶] until "ON L-1" or "ON L-2" appears on the screen.
- **If you do not use a DBS receiver**  
Press [◀ ▶] until "OFF" appears on the screen.

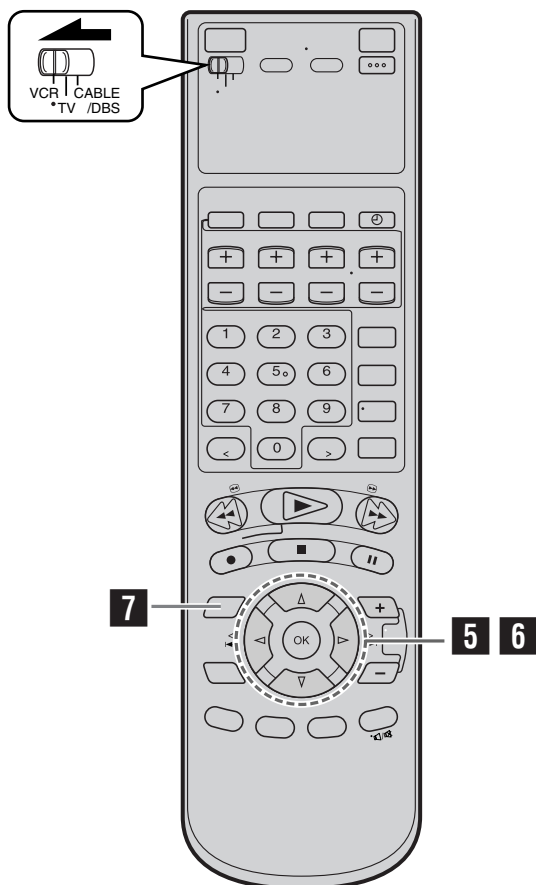

### NOTES:

- The Controller may not work with all types of DBS receiver.
- If your DBS receiver does not respond to the code, you cannot use the Controller to change satellite channels. In this case, make sure to leave the DBS receiver turned on and tuned to the proper channel before the scheduled start time of timer recording. In addition, if your DBS receiver is equipped with a timer, you can also use 'Satellite Auto Recording' (page 47).
- The VCR can only change the satellite channel through the Controller during timer recording.
- If your DBS receiver cannot be operated with a Remote (because it has no remote sensor), you cannot use the Controller to change its channels. Make sure to leave the DBS receiver turned on and tuned to the proper channel before the scheduled start time of timer recording.
- **For customers in U.S.A.:** If you are unable to set the Controller, contact JVC toll free at 1-800-252-5722.

## 5 Enter DBS Receiver's brand

Press [ $\Delta$ ▽] to move the arrow to "BRAND".

Press [ $\leftarrow$   $\rightarrow$ ] to enter the brand code from the following list.

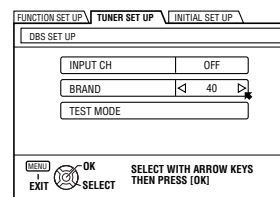

BRAND	CODE
JVC (DISH Network)	51
ECHOSTAR (DISH Network)	51
SONY (DSS)	41
RCA (DSS)	40

## 6 Engage test mode

Press [ $\Delta$ ▽] to move the arrow to "TEST MODE", then press [OK].

The program currently received through the DBS receiver appears for about 10 seconds.

### NOTE:

If you do not engage the test mode in step 6, "INPUT CH" and "BRAND" are not set.

- If the DBS receiver's channel changes to 205, setting is complete

Press [ $\leftarrow$   $\rightarrow$ ] to move the arrow to "YES", then press [OK] and "DBS RECEIVER CONTROL IS ON" appears on the screen for about 5 seconds

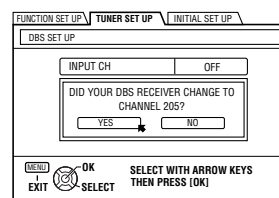

- If the DBS receiver's channel does not change as shown above

- 1 Press [ $\leftarrow$   $\rightarrow$ ] to move the arrow to "NO".
- 2 Press [OK].
- 3 Re-enter the correct code.

## 7 Return to normal screen

Press [MENU].

# Basic Playback

- Turn on the VCR and the TV, and select the AV mode on the TV.
- Set the [VCR/TV/CABLE/DBS] selector on the Remote to [VCR].

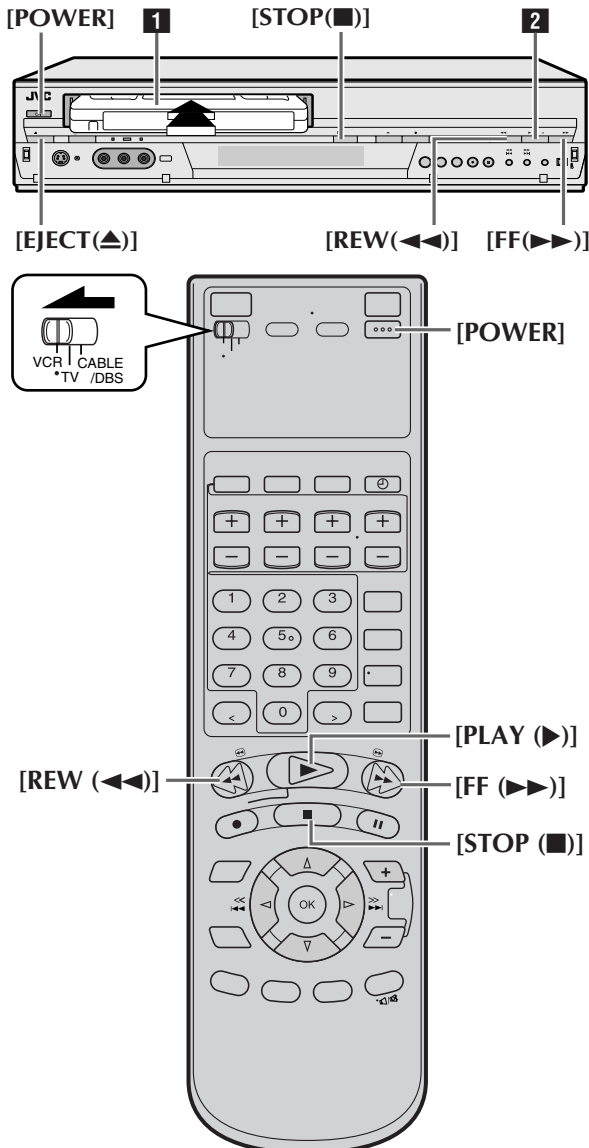

This VCR can check the tape condition during playback (and recording), and realize the best possible pictures.

- This VCR can play back tapes that have been recorded in D-VHS (MTP), S-VHS, S-VHS ET and VHS formats and automatically identifies the recording format.
- When you play back a tape recorded on this VCR, you can use the Video Navigation function (☞ page 51).

## 1 Load a cassette

Make sure the window side is up, the rear label side is facing you and the arrow on the front of the cassette is pointing towards the VCR. Do not apply too much pressure when inserting.

- The VCR turns on automatically.
- The tape will run for a few seconds while the VCR searches for the tape number. If the tape number is found, it will be shown on the TV screen if "SUPERIMPOSE" is set to "ON". (☞ page 66)
- The counter is reset automatically, however, it is not completely reset to "0:00:00".
- If the cassette's record safety tab has been removed, playback begins automatically.

## 2 Start playback

Press [PLAY (▶)].

- Recording speed is automatically detected.
- If "V. CALIBRATION" is set to "ON" (default setting) and "PICTURE CONTROL" is set to "AUTO": (☞ page 63), "VIDEO CALIBRATION" appears on the screen, and this VCR checks the tape condition during automatic tracking (only cassettes recorded in the S-VHS, S-VHS ET or VHS mode).
- During playback, if the images cannot be displayed on the TV, press [HDMI] on the front panel to turn off the [HDMI] LED and set "TV OUTPUT 2" to "ALLto480i" (☞ page 65).

In event when even the main menu screen cannot be displayed on the TV when [MENU] is pressed, power off this VCR, press and hold [PAUSE (⏸)] on the front panel for more than 5 seconds, then power on the VCR again.

### To stop playback

Press [STOP (■)] on the Remote or on the front panel.

### To rewind the tape (when it is not running)

Press [REW (◀◀)].

### To fast-forward (when it is not running)

Press [FF (▶▶)].

### To eject the tape

Press [EJECT (▲)] on the front panel when the tape is not running.

- You can also eject the cassette when the VCR is turned off.

### To turn off the VCR

Press [POWER].

## NOTES:

- When you use the Video Navigation function, operate the VCR only after the tape number is detected; otherwise, you cannot use the Video Navigation function.
- It will take a moment until the image appears when you play back cut segments (segments for which recording was continued after stopping or pausing) or segments for which recording was switched from VHS mode (SP or EP) to D-VHS mode.
- For a cassette recorded in D-VHS mode, playback is not possible if the cassette was recorded in LS5 mode.
- For component video connection, you can select the appropriate output mode in accordance to the signal received or the image format of a pre-recorded tape with "TV OUTPUT 2" (☞ page 65).

# Basic Playback Features

- Turn on the VCR and the TV, and select the AV mode on the TV.
- Set the [VCR/TV/CABLE/DBS] selector on the Remote to [VCR].

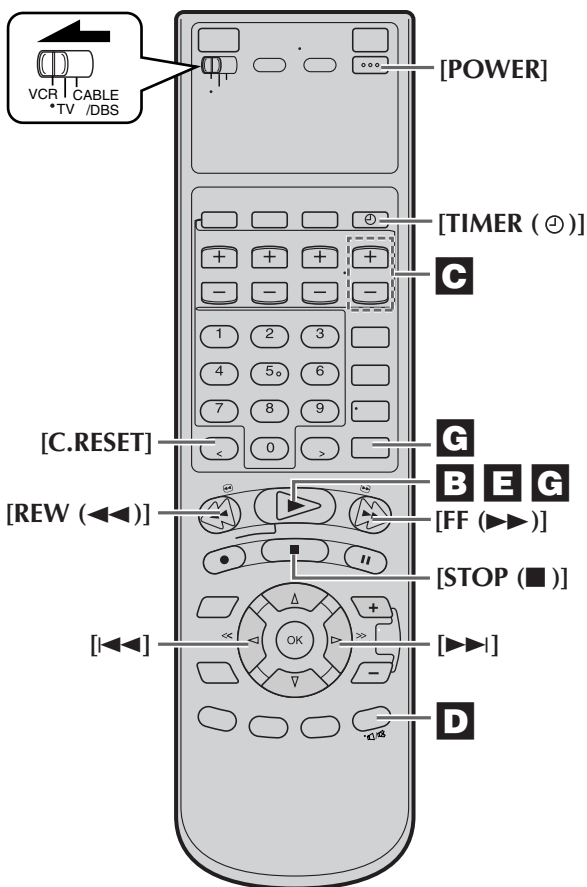
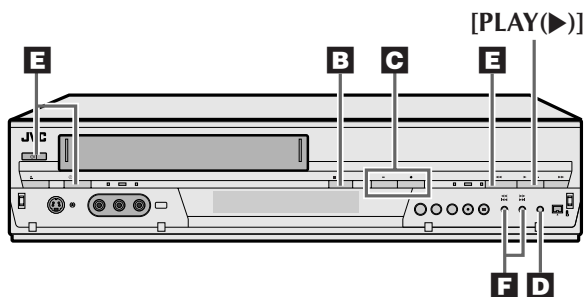

## A Checking tape position

The tape position indicator appears on the screen in the following cases:

- When you change the VCR operation mode from the stop mode to fast forward or rewind mode.
- When you perform an Index Search (page 31).

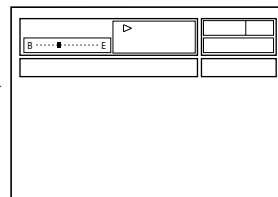

The position of "■" in relation to "B" (Beginning) or "E" (End) shows you where you are on the tape.

### NOTES:

- "SUPERIMPOSE" must be set to "ON", or the indicator will not appear (page 66).
- It may take a few seconds for the tape position indicator to be displayed.

To reset the time counter, press [C. RESET] on the Remote. The counter reading becomes "0:00:00". It is also reset when a tape is inserted.

## B Playing back tape repeatedly

### — Repeat Playback

You can play back a tape repeatedly (50 times).

While playing back a tape, press and hold [PLAY (▶)] for more than 5 seconds.

The play indicator [▶] on the front display panel starts flashing slowly, and a tape will be played back 50 times.

To stop playback, press [STOP (■)] on the Remote or on the front panel.

### NOTE:

For a cassette recorded in D-VHS mode, Repeat Playback is not possible if the cassette was recorded in LS3 mode.

## C Adjusting tracking condition

### — Tracking Adjustments

#### Automatic tracking adjustment

This VCR automatically adjusts the tracking condition. Whenever you insert a tape and start playback, automatic tracking starts working and continuously analyzes the signal to enable optimum picture quality during playback.

#### Manual tracking adjustment

If automatic tracking cannot eliminate noises well during playback, use the manual tracking following the procedures below.

- You can also use the manual tracking during slow motion playback (⏮ page 34). During slow motion playback, simply press [CHANNEL +] or [-] on the VCR (or [TV/VCR CH +] or [-] on the Remote) to adjust tracking.

## 1 Activate manual tracking

Press [CHANNEL +] and [-] on the front panel at the same time during playback.

## 2 Eliminate the noises on the TV screen

Press [CHANNEL +] or [-].

- Press it briefly for a fine adjustment, or press and hold for a coarse adjustment. Watch the screen and continue adjustment until optimum picture and sound quality are achieved.
- To reactivate automatic tracking, press [CHANNEL +] and [-] on the front panel at the same time. The automatic tracking becomes active again.

## D Selecting monitor sound

### — Audio Monitor

You can select the desired monitor sound.

**While playing back a tape on which stereo sound or SAP sound is recorded, press [A. MONITOR] on the Remote or [AUDIO MONITOR] on the front panel.**

Each time you press the button, sound changes as follows:

#### S-VHS/VHS

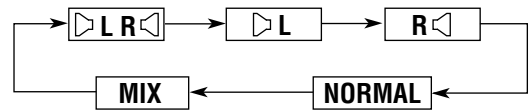

- |          |  |
|----------|--|
| "▷L R◁"  | : Normally select this.<br>Hi-Fi sound is played back.                       |
| "▷L"     | : Sound on the left Hi-Fi channel is played back.                            |
| "R◁"     | : Sound on the right Hi-Fi channel is played back.                           |
| "NORMAL" | : Sound on the normal track is played back.                                  |
| "MIX"    | : Both sounds on the Hi-Fi track and normal track are mixed and played back. |

#### D-VHS

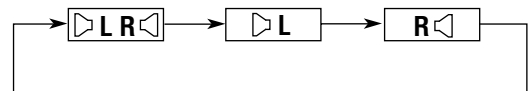

- |         |  |
|---------|--|
| "▷L R◁" | : Normally select this.                      |
| "▷L"    | : Sound on the left channel is played back.  |
| "R◁"    | : Sound on the right channel is played back. |

### NOTES:

- The above indication appears when "SUPERIMPOSE" is set to "ON" (⏮ page 66), though the monitor sound changes in sequence.
- If the tape being played back has no Hi-Fi sound track, the normal sound track will be heard regardless of this setting.

## E Automatic operations after rewinding

### — Next Function Memory

The Next Function Memory tells the VCR what to do after rewinding is complete.

- Ensure that the VCR is in stop mode.

#### a- For Automatic Playback Start

Press [REW (◀◀)], then press [PLAY (▶)] within 2 seconds.

#### b- For Automatic Power Off

Press [REW (◀◀)], then press [POWER] within 2 seconds.

#### c- For Automatic Timer Standby

Press [REW (◀◀)], then press [TIMER (⊙)] within 2 seconds.

### NOTE:

It is not possible to select the Automatic Timer Standby function if the cassette's record safety tab is removed.

## F Locating beginning of recordings

### — Index Search

When recording on this VCR, index codes are placed on the tape at the beginning of each recording. You can find and automatically play back from the beginning of any recording using the Index Search function.

## 1 Start search

While the tape is not running, press [◀◀] or [▶▶] on the Remote or the front panel.

## 2 Access distant code

To access a recording of 2 to 9 index codes away, press [◀◀] or [▶▶] repeatedly until the correct number is displayed on the screen (only if "SUPERIMPOSE" is set to "ON" (☞ page 66)). Playback begins automatically when the desired recording is located.

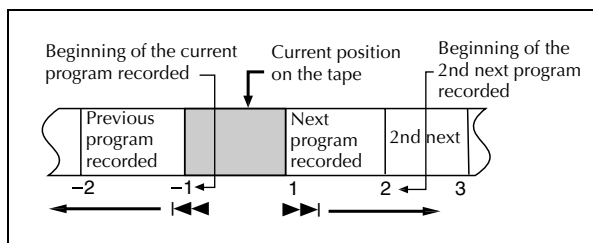

- If you want to find the very beginning of the desired program, press [REW (⊙)] or [FF (⊙)] after playback starts.

### NOTE:

An index code is not placed on the tape when recording is resumed from recording pause.

## G Skipping unwanted portions

### — Skip Search

You can skip over (view at high speed) unwanted portions of the tape.

Press [SKIP SEARCH] on the Remote once to 6 times during playback.

Each press initiates a 30-second period of high speed playback (up to 3 minutes). When the specified portion of the tape is skipped, normal playback resumes automatically.

To return to normal playback during Skip Search, press [PLAY (▶)].

### Other Useful functions for playback (S-VHS/VHS only)

You can also use the following functions for playback.

- **"V. CALIBRATION"** (☞ page 63)  
When this function is set to "ON", this VCR checks the condition of the tape in use during playback and recording, and compensates to provide the highest-possible pictures.
- **"PICTURE CONTROL"** (☞ page 63)  
This function helps you to adjust the playback picture quality according to your preference.
- **"VIDEO STABILIZER"** (☞ page 63)  
You can automatically correct vertical vibrations in the picture when playing back unstable recordings made on another VCR.

Some D-Theater tapes or D-VHS tapes may contain multiple programs, angles, sounds or subtitles. If a tape contains them, the icons appear on the top right corner of the TV screen when you press [OSD].

### Program Selection

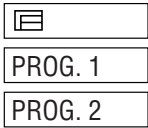

During normal playback, press [TV/VCR CH +/-] on the Remote to select the desired program.

- It is impossible to select the program if the tape does not contain multiple programs.

### Angle Selection

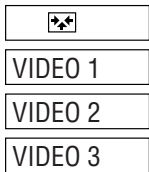

During normal playback, press the 'Number' key [4] on the Remote to select the desired angle.

- It is impossible to select the angle if the tape does not contain multiple angles.

### Sound Selection

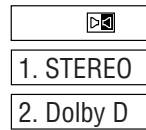

During normal playback, press [A. MONITOR] on the Remote or [AUDIO MONITOR] on the front panel to select the desired sound.

- It is impossible to select the program if the tape does not contain multiple programs.
- The [DOLBY-D], [PCM] or [DTS] LED on the front panel will light up in accordance to the selected sound (Dolby Digital, PCM or DTS).

### Subtitle Selection

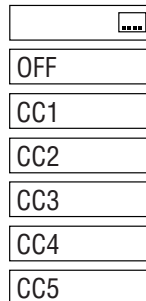

During normal playback, press [SUBTITLE] ('Number' key [6]) on the Remote to select the desired subtitle.

- It is impossible to select the subtitle if the tape does not contain multiple subtitles.

### **ATTENTION:**

*Subtitles do not appear while the on-screen display is displayed.*

### **NOTE:**

*When you record multiple programs or programs with multiple angles, it is impossible to change program on multiple program channel and angles with the control of this VCR. Select the desired program or angle with the control of the TV.*



# Special Effect Playback

- Turn on the VCR and the TV, and select the AV mode on the TV.
- Set the [VCR/TV/CABLE/DBS] selector on the Remote to [VCR].

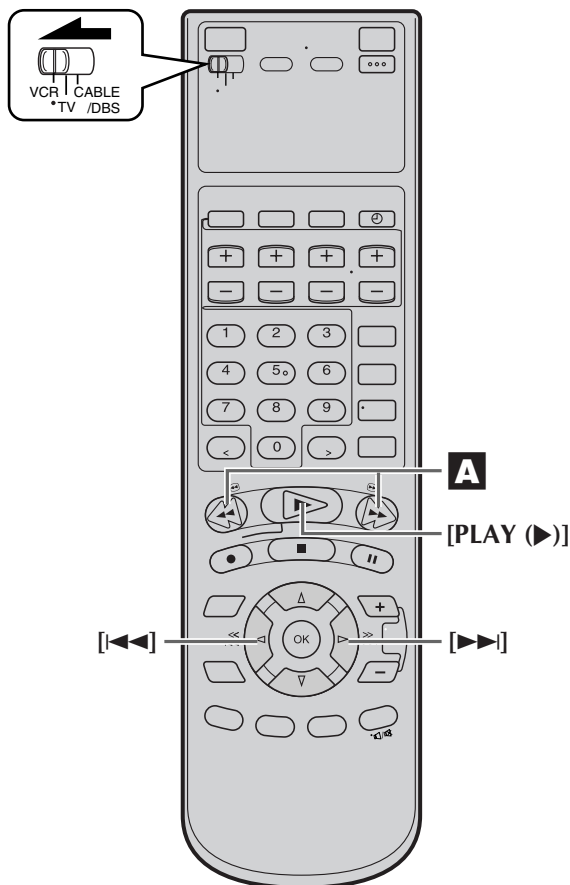

With this VCR, you can enjoy special effect playback such as high-speed search, variable-speed search, and still playback and so on.

## A Locating particular scene rapidly

### — Picture Search

#### ■ High-Speed Picture Search

Possible during normal playback or still picture playback. You can rapidly locate a particular scene on the tape.

**To do forward picture search**, press [FF (⏩)].

**To do reverse picture search**, press [REW (⏮)].

- The speed changes for each direction by pressing [REW (⏮)] and [FF (⏩)] repeatedly.

**To resume normal playback**, press [PLAY (▶)].

#### NOTES:

- The high-speed picture search speed of the D-VHS recording is 6 times normal playback speed in HS mode, 12 times in STD mode and 36 times in LS3 mode. The high-speed picture search speed of the S-VHS/VHS recording is 11 times normal playback speed in SP mode, 31 times in EP mode.
- The picture may be distorted at the part where the playback speed is changed.
- Mosaic (block) noise and still picture may appear during the high-speed picture search of a tape recorded in D-VHS format on other devices.

#### ■ Variable-Speed Picture Search (S-VHS/VHS only)

You can change the speed of picture search.

#### How to use the buttons on the Remote:

**To do forward picture search**, press [▶▶] repeatedly. Each time you press the button, the search speed increases.

- To decrease the speed during forward picture search (toward normal playback, then reverse picture search), press [◀◀] repeatedly.

**To do reverse picture search**, press [◀◀] repeatedly. Each time you press the button, the search speed increases during reverse picture search.

- To decrease the speed during reverse picture search (toward normal playback, then forward picture search), press [▶▶] repeatedly.

**To resume normal playback**, press [▶].

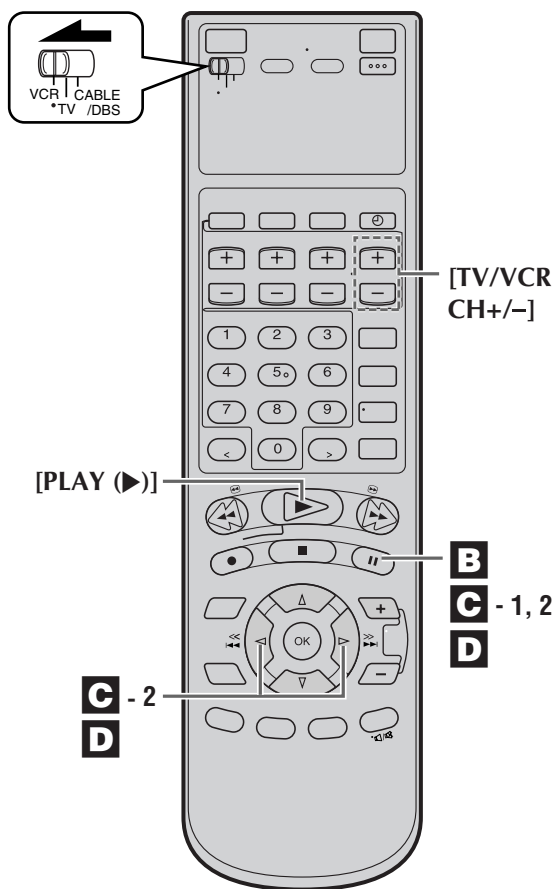

## B Viewing still picture

### — Still Picture Playback

Press [PAUSE (II)] during normal playback. The pause indicator (III) on the front display panel lights up. Playback is frozen and a still picture appears.

To resume normal playback, press [PLAY (▶)].

#### NOTES:

- To obtain a noiseless still picture, it may be necessary to adjust tracking in slow motion playback before starting still picture playback.
- Manual tracking is possible during still picture playback. During still picture playback, simply press [CHANNEL +] or [-] on the VCR (or [TV/VCR CH +] or [-] on the Remote) to adjust tracking.

## C Viewing still picture frame by frame

### — Frame-by-Frame Playback (S-VHS/VHS only)

### 1 Pause during playback

Press [PAUSE (II)]. Playback is frozen and a still picture appears.

### 2 Advance or reverse still picture

To advance a still picture, press [▶▶] or [PAUSE (II)] repeatedly.

To reverse a still picture, press [◀◀] repeatedly.

To resume normal playback, press [PLAY (▶)].

## D Viewing slow motion picture

### — Slow Motion Playback (S-VHS/VHS only)

#### During normal playback:

Press [◀◀] to decrease the playback speed. Each time you press the button, the speed decreases (toward reverse slow motion playback, then reverse picture search).

- Holding [PAUSE (II)] for more than 2 seconds also starts forward slow motion playback. If you press [PAUSE (II)] again, still picture resumes.

To resume normal playback, press [PLAY (▶)].

#### During still picture playback:

Press and hold [▶▶] to start forward (or [◀◀] to start reverse) slow motion playback. When you release the button, slow motion playback stops and a still picture appears.

- Holding [PAUSE (II)] for more than 2 seconds also starts forward slow motion playback. If you press [PAUSE (II)] again, still picture resumes.

To resume normal playback, press [PLAY (▶)].

#### NOTES:

- Manual tracking is possible during slow motion playback. During slow motion playback, simply press [CHANNEL +] or [-] on the VCR (or [TV/VCR CH +] or [-] on the Remote) to adjust tracking.
- When the picture jitters vertically during slow motion playback, press [PAUSE (II)] to enter still picture mode. Then adjust tracking by pressing [CHANNEL +] or [-].

# Basic Recording

- Turn on the TV (and/or Digital Set Top Box), and select the channel to be recorded.
- Set the [VCR/TV/CABLE/DBS] selector on the Remote to [VCR].

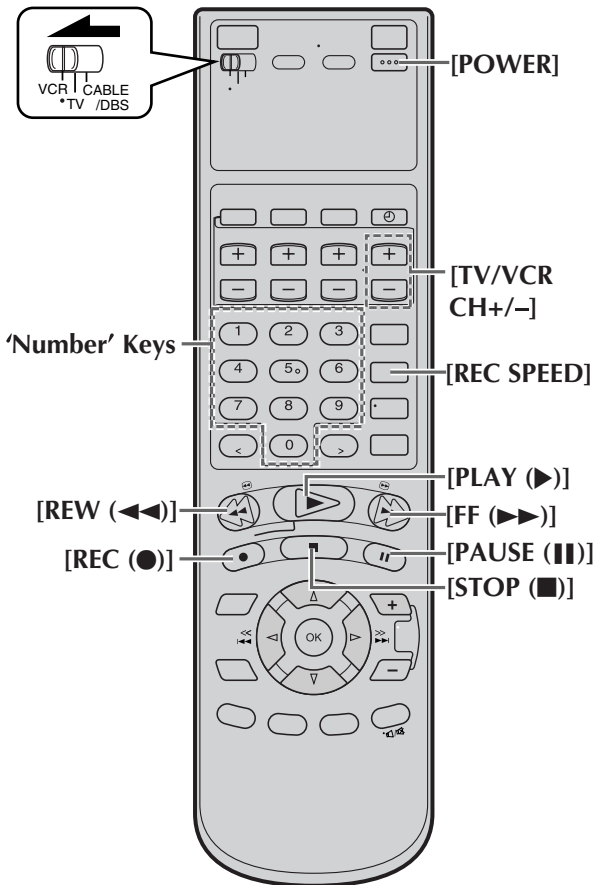
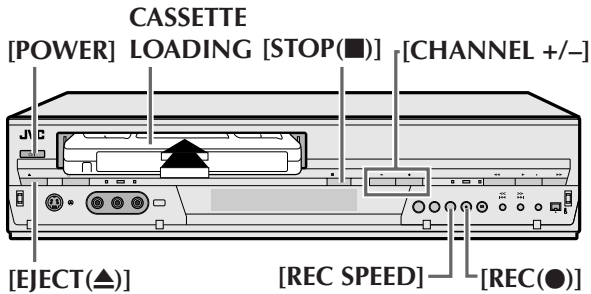

**NOTES:**

- When a new D-VHS tape is inserted, "AUT" is always selected regardless of the previous recording speed selected.
- You can perform D-VHS recording of a program which is timer-programmed on your Integrated HDTV (or Digital Set Top Box) by using 'i.LINK Timer Programming' (see page 48).

This VCR can check the tape condition during recording (and playback), and realizes the best possible pictures.

In addition, this VCR is equipped with the Video Navigation function, which allows you to quickly locate the programs you have recorded on a tape. When recording on this VCR, the tapes are automatically numbered so that every tape recorded on this VCR has a different tape number. With this function, the program information such as recording date, start time, channel number, and recording speed are also automatically stored in the VCR's memory.

- For the Video Navigation function, see page 51. To memorize the recording date and start time for the Video Navigation function, the date and clock must be set correctly.

## D-VHS Recording via i.LINK Connection

### 1 Set up link between this VCR and the Integrated HDTV or Digital Set Top Box

- Select i.LINK connection at the Integrated HDTV or Digital Set Top Box. For details, refer to the instruction manual of the Integrated HDTV or Digital Set Top Box.

### 2 Load a D-VHS cassette

Make sure the record safety tab is intact. If not, cover the hole with adhesive tape before inserting the cassette.

- The [D-VHS] LED on the front panel and [D-VHS] indicator on the front display panel light up and the D-VHS recording mode is enabled.

### 3 Select recording channel (i.LINK input)

**On the front panel:**

Press [CHANNEL +] or [-] to select "I-1" etc.

**On the Remote:**

Press [TV/VCR CH +] or [-] to select "I-1" etc.

- Set "LINC" to "AUTO". (see page 70)
- Confirm that a link has been established between this VCR and the Integrated HDTV or the Digital Set Top Box.

### 4 Set recording speed

Press [REC SPEED] to set the recording speed.

- The recording speed changes each time [REC SPEED] is pressed.

**"AUT":** When recording in HS or STD mode (AUTO) is selected automatically according to the amount of data input (transfer rate) of the program.

**"HS":** When picture quality and sound quality are important.

**"STD":** When picture quality and recording time are important.

### 5 Start recording

**On the front panel:**

Press [REC (●)].

**On the Remote:**

While holding [REC (●)], press [PLAY (▶)].

## D-VHS/S-VHS/VHS Recording

### 1 Load a cassette

Make sure the record safety tab is intact. If not, cover the hole with adhesive tape before inserting the cassette.

- The [D-VHS], [S-VHS] or [VHS] indicator on the front display panel will light up respectively in accordance to the type of cassette inserted (D-VHS, S-VHS or VHS). The respective recording mode is enabled.

### 2 Select recording channel

**On the front panel:**

Press [CHANNEL +] or [-].

**On the Remote:**

a- Press [TV/VCR CH +] or [-].

or

b- Press the 'Number' keys.

### 3 Set recording speed

Press [REC SPEED] to set the recording speed.

- The recording speed changes each time [REC SPEED] is pressed.

**During D-VHS recording,**

**"AUT":** When recording in HS or STD mode (AUTO) is selected automatically according to the amount of data input (transfer rate) of the program.

**"HS":** When picture quality and sound quality are important.

**"STD":** When picture quality and recording time are important.

**"LS3":** To record for three times longer than in STD mode, with picture quality that is equal to or better than S-VHS.

**During S-VHS/VHS recording,**

**"SP":** When picture quality is important in S-VHS/S-VHS ET/VHS recording mode.

**"EP":** To record for three times longer in S-VHS/S-VHS ET/VHS mode.

### 4 Start recording

**On the front panel:**

Press [REC (●)].

**On the Remote:**

While holding [REC (●)], press [PLAY (▶)].

- During S-VHS/VHS recording, if "V. CALIBRATION" is set to "ON" (default setting:  page 63), this VCR checks the tape condition for about seven seconds, then starts recording. This means that the first seven seconds of the program will not be recorded. If this is inconvenient for you, follow the steps below:

① Press [REC (●)] and [PAUSE (⏸)] to start Video Calibration.

② Then press [PLAY (▶)] to start recording after Video Calibration is complete.

**To pause recording**

Press [PAUSE (⏸)]. The pause indicator [⏸] on the front display panel lights up.

To resume recording, press [PLAY (▶)].

**To stop recording**

Press [STOP (■)] on the Remote or on the front panel.

**To rewind the tape (when it is not running)**

Press [REW (◀)].

**To fast-forward the tape (when it is not running)**

Press [FF (▶▶)].

**To eject the tape**

Press [EJECT (▲)] on the front panel when the tape is not running.

- You can also eject the cassette when the VCR is turned off.

**To turn off the VCR**

Press [POWER].

### Compatibility Of Cassettes And Recording Mode

Cassette	Recording Mode		
	D-VHS	S-VHS	VHS
D-VHS	Yes	Yes	Yes
S-VHS	No	Yes	Yes
VHS	No	Yes*	Yes

\* To record on the VHS cassette with S-VHS quality, use the S-VHS ET function ( page 68).

### NOTES:

- The D-VHS (MTP), S-VHS, S-VHS ET and VHS mode recordings are possible with this VCR.
- To record in the D-VHS mode, use a D-VHS cassette.
- To record in the S-VHS/VHS mode, you can use a D-VHS, S-VHS or VHS cassette.

**To record in S-VHS mode on D-VHS tapes:**

Press [D-VHS] to turn off the [D-VHS] LED and [D-VHS] indicator. Then, set "S-VHS MODE" to "ON" ( page 67).

**To record in VHS mode on D-VHS tapes:**

Press [D-VHS] to turn off the [D-VHS] LED and [D-VHS] indicator. Then, set "S-VHS MODE" to "OFF" ( page 67).

It may be unlawful to record or play back copyrighted material without the consent of the copyright owner.

**During EE mode (viewing TV program through the VCR channel),**

The subtitles of the program will not be displayed through the HDMI connection. To view the subtitles, please make use of the analog connection (Component Video, S-Video or Video), and set "TV OUTPUT 2" to "ALLto480i" ( page 65). However, if the picture is of 480p image format, the subtitles cannot be displayed.

# Basic Recording Features

- Turn on the VCR and the TV, and select the AV mode on the TV.
- Set the [VCR/TV/CABLE/DBS] selector on the Remote to [VCR].

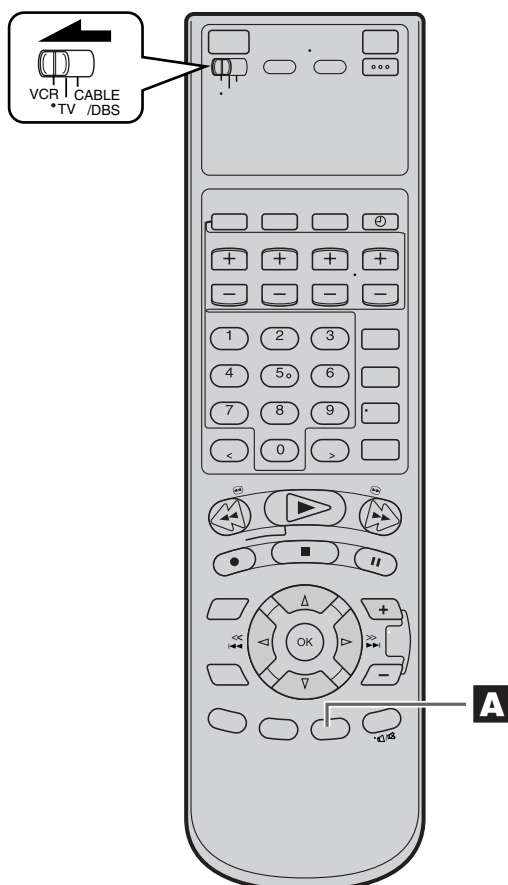
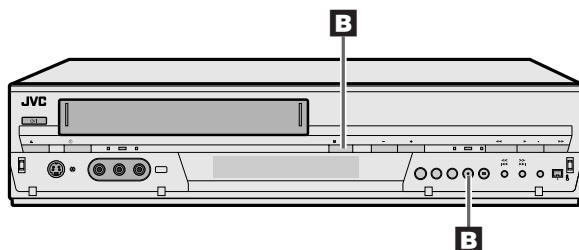

## A Changing display information

Press [DISPLAY].

Each time you press the button, the front display panel shows the clock time, remaining time and the time counter in sequence.

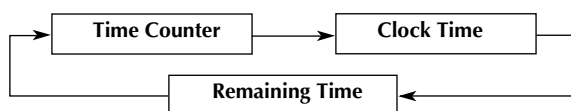

- The remain [▷] indicator will be displayed when the front display panel shows the remaining time.
- To display the VCR status including the time counter, the channel number and the clock time on the TV screen, see 'Showing on-screen display' (page 38).

## B Specifying recording length

### — Instant Timer Recording (ITR)

You can easily specify the recording length from 30 minutes to 8 hours and the VCR shuts off after recording is finished.

**During recording, press [REC (●)] on the front panel repeatedly until the recording length you want appears on the front display panel.**

The record [○] indicator starts flashing.

Each time you press the button, recording length increases in 30-minute intervals (up to 8 hours).

**To cancel an ITR, press [STOP (■)] on the Remote or on the front panel.**



## C Watching one program while recording another

### 1 Engage TV mode

During recording...

- Change the TV's input mode from AV to TV.

### 2 Select channel for viewing

Select the channel you want to watch, on the TV.

## D Showing on-screen display

When "SUPERIMPOSE" is set to "ON" (page 66), you can see the current VCR status on the TV screen.

- For more detailed information about the on-screen display, see page 10.

### 1 Display VCR status on TV screen

During recording or recording pause, press [OSD] on the Remote. All indications corresponding to the current VCR status are displayed for 5 seconds.

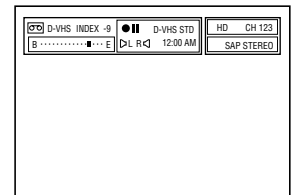

The time counter remains on the screen indicating the elapsed time.

- The indications are not recorded.

### 2 Exit on-screen display

Press [OSD] again.

## NOTES:

- The subtitles does not appear while the on-screen display is displayed.
- If the VCR is in recording pause mode, "●||" is always displayed.
- The VCR status can be also displayed during playback.
- Even if "SUPERIMPOSE" is set to "OFF" (page 66), the on-screen display appears when the VCR plays back the blank portion of a tape and the VCR receives the channel which has no broadcast. However, on-screen display does not appear when the input location is selected and no signal is input.

**Other useful functions for recording**

You can also use the following functions for recording.

- **“V. CALIBRATION” (S-VHS/VHS only)** (☞ page 63)

When this function is set to “ON”, this VCR checks the condition of the tape in use during playback and recording, and compensates to provide the highest-possible pictures.

- **Second Audio Recording** (☞ page 64)

This VCR’s built-in MTS decoder enables reception of Multichannel TV Sound broadcast.

To record a SAP program received, set “2ND AUDIO REC” to “ON” using the menu screen.

**NOTES:**

*When the channel is changed on the VCR;*

- The “STEREO” indication appears on the screen for about 5 seconds if the program is a stereo broadcast.
- The “SAP” indication appears on the screen for about 5 seconds if the program is a SAP broadcast.
- The “SAP STEREO” indication appears when a stereo program is accompanied by SAP sound.

- **S-VHS Recording Mode** (☞ page 67)

This VCR allows you to record on a D-VHS and S-VHS tape with VHS picture quality.

- **“S-VHS ET”** (☞ page 68)

This function allows you to record on VHS tapes with S-VHS picture quality. Tapes recorded using this function can be played back on a VCR equipped with the S-VHS ET function.

**Accidental erasure prevention**

To prevent accidental recording on a recorded cassette, remove its record safety tab.

To record on it later, cover the hole with adhesive tape.

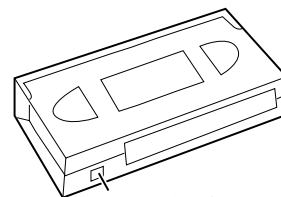

Record safety tab

# VCR Plus+ C<sup>3</sup>®

## Timer Programming

- Turn on the VCR and the TV, and select the AV mode on the TV.
- Set the [VCR/TV/CABLE/DBS] selector on the Remote to [VCR].

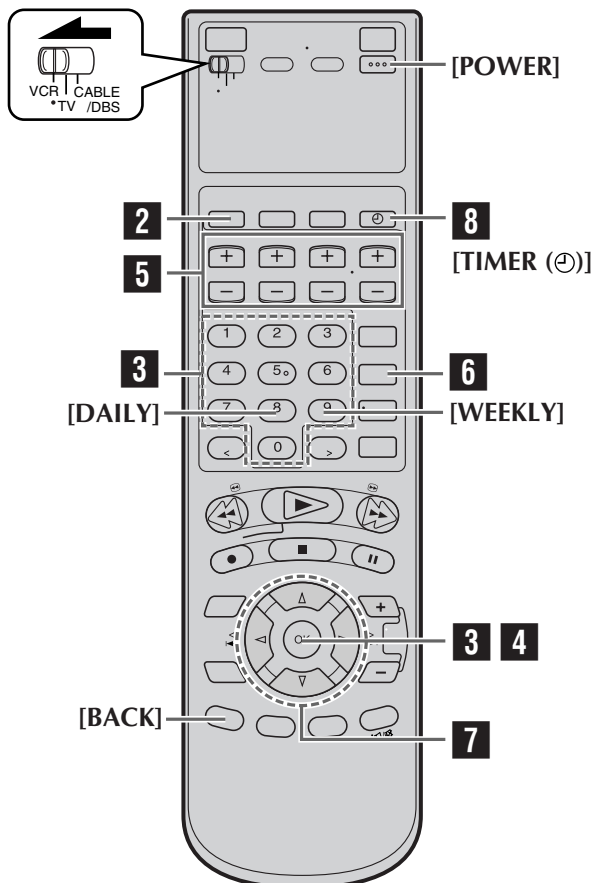
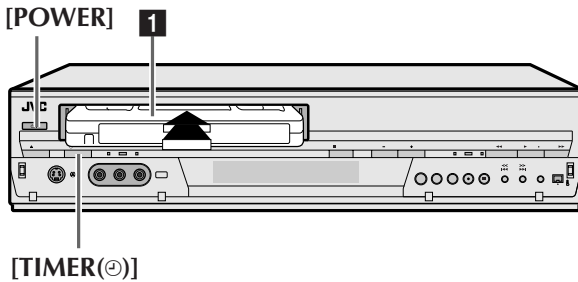

Timer recording allows you to program the VCR to automatically record a broadcast at some future time. Up to 24 timer recording programs can be made using VCR Plus+ timer programming or Express timer programming method (see page 44) as far as a year in advance. The VCR Plus+ timer programming system eliminates the need to input channel, date, start and stop time data when programming timer recording settings. Simply key in the PlusCode number for the TV broadcast you wish to record and the VCR's timer will be automatically programmed. (The PlusCode programming numbers are the numbers next to the program in most TV listing.)

### 1 Load a cassette

Make sure the record safety tab is intact. If not, cover the hole with adhesive tape, then load it into the VCR.

- The VCR turns on, and the counter is reset, automatically.

### 2 Access VCR Plus+ screen

Press [PROGRAM] on the Remote.

- The clock must be set to access the VCR Plus+ screen. If you have not set the clock, the Main Menu screen appears after an error message is displayed. Refer to page 17 for the clock setting procedure.

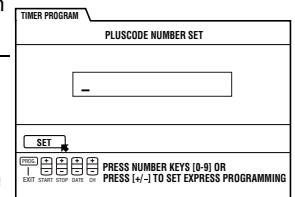

### 3 Enter PlusCode number

Press the appropriate 'Number' keys to input the PlusCode number printed in the TV listings for the TV broadcast you wish to record, then press [OK].

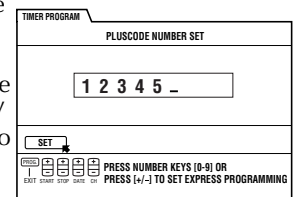

Then;

If the Guide Channel Set screen appears

— go to step 4.

If the VCR Plus+ Program screen appears

— go to step 5.

- To make corrections, press [CANCEL] and input the correct PlusCode number.
- If an incorrect PlusCode number or one where the broadcast already ended has been inputted, "PLUSCODE NO. ERROR CONFIRM PLUSCODE NO. THEN RETRY" is displayed for about 5 seconds, then the VCR Plus+ screen reappears.



## 4 Input receiving channel number

The guide channel number, which is assigned to the TV or cable station for the PlusCode number that you entered in step 3, will appear automatically on the Guide Channel Set Up screen.

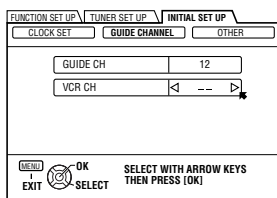

Press [◀ ▶] to input the number of the channel on which the broadcast for the PlusCode number is received on the VCR or cable box, then press [OK].

- The Guide Channel Set screen appears only when you input the PlusCode number of a station for which the guide channel number has not been set previously.
- If you receive your channels with a cable box and if you have properly set your Controller, "CABLE CH" appears in place of "VCR CH". If not, refer to pages 22 - 24. In that case, it is possible to change the channel by 10 channels by pressing and holding [◀ ▶].

## 5 Check program data

The PlusCode number you entered and the corresponding timer recording program is displayed on the Program screen. Check to make sure it is accurate.

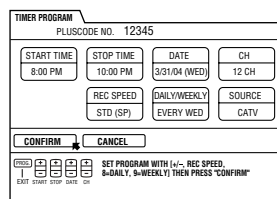

- To change the start/stop time, date or channel setting, press the corresponding buttons to change the settings; [START +/-], [STOP +/-], [DATE +/-], [TV/VCR CH +/-].
- To timer-record daily or weekly serials, press [DAILY] (number [8]) or WEEKLY (number [9]). "MON - FRI", "MON - SAT", "SUN - SAT" or "EVERY \_ \_ \_" appears on the Program screen.
- Pressing the button again makes each corresponding display disappear.
- For the "SOURCE" setting, refer to page 45.
- If you made a mistake, press [BACK] to access the VCR Plus+ screen again and input the correct PlusCode number.

## 6 Set recording speed

Press [REC SPEED] to set the recording speed.

## 7 Return to normal screen

Press [◀ ▶] to move the arrow to "CONFIRM", then press [OK]. "PROGRAM COMPLETED PRESS [TIMER] TO ENTER TIMER STANDBY MODE" appears on the screen, then press [OK] to return to normal screen.

## 8 Engage timer recording standby mode

Press [TIMER (⊙)].

The VCR turns off automatically and [⊙] is displayed on the front display panel.

### To use the VCR while it is in timer recording standby mode

Press [TIMER (⊙)] to cancel the timer recording standby mode, then press [POWER] to turn on the VCR.

DO NOT forget to put the VCR into timer recording standby mode again by pressing [TIMER (⊙)] after you use the VCR; otherwise, you cannot record the broadcasts you want.

- When "AUTO TIMER" (⊙ page 66) is set to "ON", the timer recording standby mode is automatically engaged when the VCR is turned off. It is temporarily canceled when the VCR is turned on. You do not have to press [TIMER (⊙)] to engage or disengage the timer recording standby mode.

### IMPORTANT:

If you have moved to a different area or if a broadcasting station's channel number has been changed, the wrong VCR CH or CABLE CH number will be displayed on the Program screen in step 5. When this happens, set the correct guide channel number for that station. (⊙ page 42, 'Changing VCR Plus+ C<sup>3</sup>® Setting')

### NOTES:

- Even if a power failure occurs, the VCR keeps your timer programs. However, the clock time is lost if it lasts for more than 10 minutes. As a result, when the power is supplied again to this VCR after the power failure, the following will take place.
  1. This VCR starts Auto Clock Set automatically to restore the clock time.
  2. If the clock time is restored correctly and "AUTO TIMER" is set to "ON", each timer program you have made will start at its start time unless its end time has elapsed.
- If the tape reaches its end during timer recording, [⊙], [⊙], and [▶] blink.
- To timer-record cable channels received through a cable box, be sure to keep the cable box turned on.

# Changing VCR Plus+ C<sup>3</sup>® Setting

- Turn on the VCR and the TV, and select the AV mode on the TV.
- Set the [VCR/TV/CABLE/DBS] selector on the Remote to [VCR].

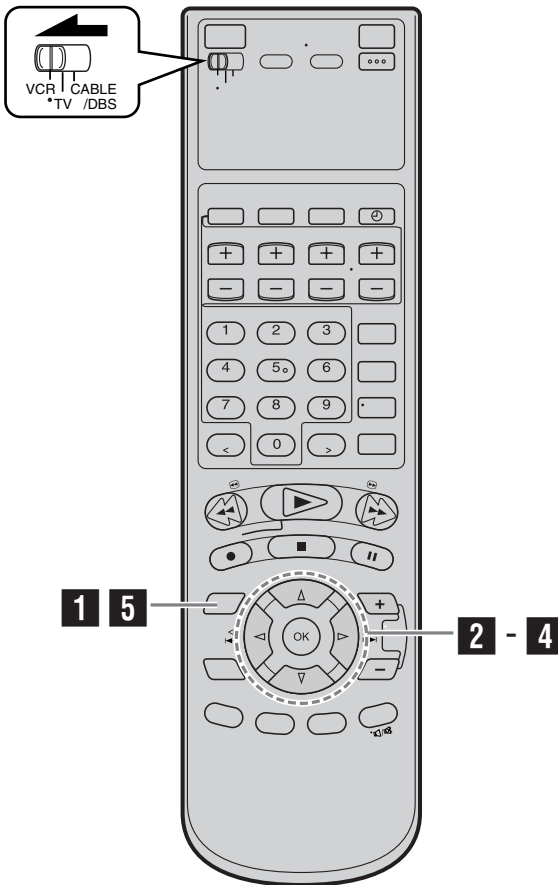

## IMPORTANT:

If you have moved to a different area or if a broadcasting station's channel number has been changed, the wrong VCR CH or CABLE CH number will be displayed on the Program screen (see page 41 step 5). When this happens, perform the following steps to set the correct guide channel number for that station.

To ensure that VCR Plus+ timer recording operates correctly, it is necessary to set the VCR Plus+ "Guide Channel Set" for each station. Read the following information carefully.

## VCR Plus+ guide channel matching

The VCR Plus+ programming system assigns a VCR Plus+ guide channel to the TV channels and the cable channels. These guide channel numbers are also called the VCR Plus+ channel codes. TV listings often have a section in chart form, indicating the guide channel number assigned to each station. For accurate VCR Plus+ programming, the VCR Plus+ guide channel number for each station should match the channel number on which it is received in your area.

## NOTES:

- In many instances, the VCR Plus+ guide channel numbers for cable and broadcast TV stations DO NOT match the channel number on which it is received by your VCR or cable box. Check your TV listing, or contact your cable supplier for details.
- Many TV stations can be viewed on cable. Check your TV listing, or contact your cable supplier for details.

## 1 Access Main Menu screen

Press [MENU].

## 2 Access Guide Channel Set screen

- 1 Press [◀ ▶] to move the arrow to "INITIAL SET UP", then press [▽] or [OK].
- 2 Press [◀ ▶] to move the arrow to "GUIDE CHANNEL", then press [▽] or [OK].

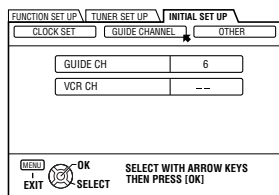

## 3 Input guide channel number

Press [◀ ▶] to input the VCR Plus+ guide channel number as shown in the TV listing.

- If you receive your channels with a cable box and if you have properly set your Controller, "CABLE CH" appears in place of "VCR CH". If not, refer to pages 22 - 24 and re-perform the procedure.

In that case, it is possible to change the channel by 10 channels by pressing and holding [◀ ▶] in steps 3 and 4.

(Eg.) When inputting the guide channel number for number 6 WNJU(Ind.)

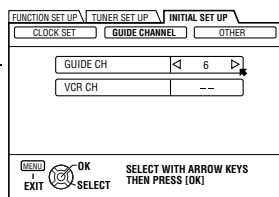

## 4 Input receiving channel number

Press [△▽] to move the arrow to "VCR CH", then press [◀ ▶] to input the number of the channel on which the guide channel's broadcasts are received.

(Eg.) If WNJU(Ind.) is received on channel 47

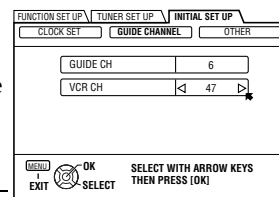

- Repeat steps 3 and 4 for each instance.

## 5 Return to normal screen

Press [MENU].

# Express Timer Programming

- Turn on the VCR and the TV, and select the AV mode on the TV.
- Set the [VCR/TV/CABLE/DBS] selector on the Remote to [VCR].

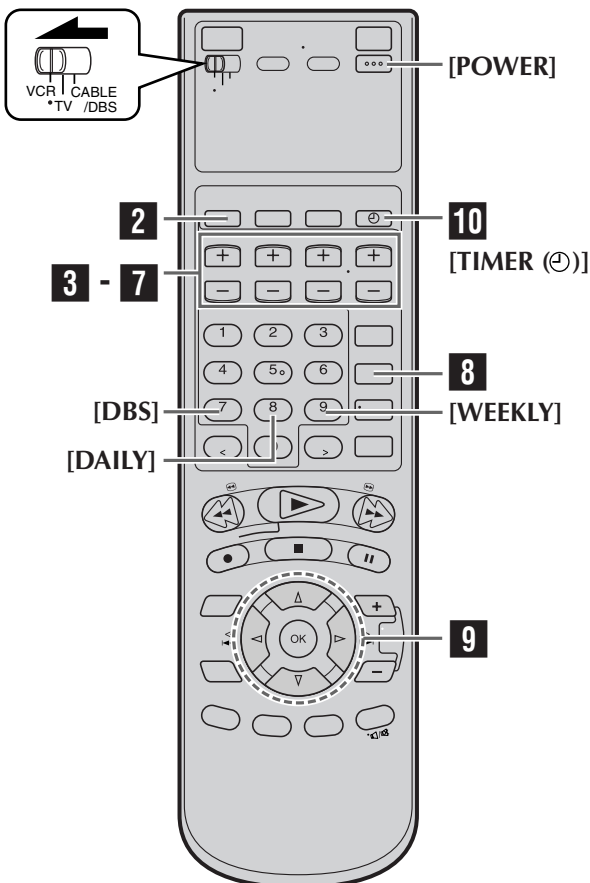
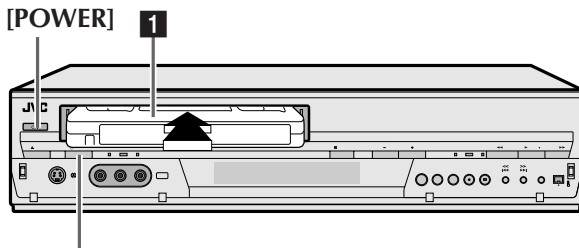

You can directly program the VCR's timer to record up to 24 broadcasts, as far as a year in advance. Remember, the clock must be set before you can program the timer (page 17).

## 1 Load a cassette

Make sure the record safety tab is intact. If not, cover the hole with adhesive tape, then load it into the VCR.

- The VCR turns on, and the counter is reset, automatically.

## 2 Access VCR PLUS+ screen

Press [PROGRAM].

## 3 Access Program screen

Press [START +/-] once.

## 4 Set program start time

Press [START +/-] repeatedly to enter the time you want recording to start.

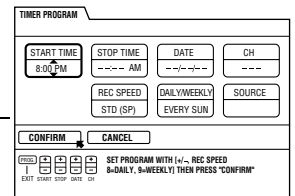

- Press and hold [START +/-] to increase or decrease the time in 30-minute intervals.

## 5 Set program stop time

Press [STOP +/-] repeatedly to enter the time you want recording to stop.

- Press and hold [STOP +/-] to increase or decrease the time in 30-minute intervals.

## 6 Set program date

Press [DATE +/-]. (The current date is displayed on the screen. The date you enter appears in its place.)

## 7 Set channel number

Press [TV/VCR CH +/-].

- If you are using a DBS receiver, see 'ATTENTION FOR DBS RECEIVER USERS' on next page.
- Holding down [TV/VCR CH +/-] rapidly changes the channel numbers.

## 8 Set recording speed

Press [REC SPEED] to set the recording speed.

## 9 Return to normal screen

Press [◀ ▶] to move the arrow to "CONFIRM", then press [OK].  
"PROGRAM COMPLETED PRESS [TIMER] TO ENTER TIMER STANDBY MODE" appears on the screen, then press [OK] to return to normal screen.

## 10 Engage timer recording standby mode

Press [TIMER (⊙)].  
The VCR turns off automatically and [⊙] is displayed on the front display panel.

### To timer-record daily or weekly serials

Press [DAILY] (number [8]) or [WEEKLY] (number [9]) anytime during steps 4 through 8.

"MON – FRI", "MON – SAT", "SUN – SAT" or "EVERY \_ \_ \_" appears on the Program screen.

- Pressing the button again makes the corresponding indication disappear.

### To use the VCR while it is in timer recording standby mode

Press [TIMER (⊙)] to disengage the timer recording standby mode, then press [POWER] to turn on the VCR. DO NOT forget to re-engage timer recording standby mode again by pressing [TIMER (⊙)] after you use the VCR; otherwise, you cannot record the broadcast you want.

- When "AUTO TIMER" (⊞ page 66) is set to "ON", the timer recording standby mode is automatically engaged when the VCR is turned off. It is temporarily canceled when the VCR is turned on. You do not have to press [TIMER (⊙)] to engage or disengage the timer recording standby mode.

## NOTES:

- Even if a power failure occurs, the VCR keeps your timer programs. However, the clock time is lost if it lasts for more than 10 minutes.
- As a result, when the power is supplied again to this VCR after the power failure, the following will take place.
  - This VCR starts Auto Clock Set automatically to restore the clock time.
  - If the clock time is restored correctly and "AUTO TIMER" is set to "ON", each timer program you have made will start at its start time unless its end time has elapsed.
- Programs that start after midnight must have the next day's date.
- After timer recording is completed, the VCR turns off automatically.
- You can program the timer recording while a regular recording is in progress; the menu screens will not be recorded.
- If the tape reaches its end during timer recording, [⊙], [◻], and [▶] blink.
- To timer-record cable or satellite channels, be sure to keep the cable box or DBS receiver turned on.

### ATTENTION FOR DBS RECEIVER USERS

If you are using a DBS receiver (unless "INPUT CH" is set to "OFF" on DBS Receiver Set screen ⊞ page 26), the band indication ("TV", "CATV" or "DBS") appears under the channel number indication ("SOURCE").

TIMER PROGRAM			
START TIME 8:00 PM	STOP TIME 10:00 PM	DATE 3/24/04 (WED)	CH 110 CH
REC SPEED STD (SP)	DAILY/WEEKLY EVERY WED	SOURCE DBS	
CONFIRM		CANCEL	
<small>SET PROGRAM WITH [←], [→], [REC SPEED], [DBS], [DAILY], [WEEKLY] THEN PRESS "CONFIRM"</small> <small>EXIT: START STOP DATE CH</small>			

"TV" : To timer-record a regular TV broadcast received on the VCR.

"CATV" : To timer-record a cable TV broadcast received on the VCR, or through a cable box (unless "INPUT CH" is set to "OFF" on Cable Set Up screen ⊞ page 23).

"DBS" : To timer-record a satellite broadcast received through a DBS receiver.

### NOTE:

If "BAND" is set to "TV" on the Tuner Set Up Screen ⊞ page 21) and "INPUT CH" is set to "OFF" on Cable Set Up screen ⊞ page 23), "CATV" will not be displayed on the Program screen; If "BAND" is set to "CATV" or "INPUT CH" is set to "ON" on Cable Set Up screen, "TV" will not be displayed.

If the channel number entered requires that the band be set, "7=DBS" is displayed on the screen. If this happens, press the 'Number' key [7 (DBS)] to select "DBS".

- Turn on the VCR and the TV, and select the AV mode on the TV.
- Set the [VCR/TV/CABLE/DBS] selector on the Remote to [VCR].

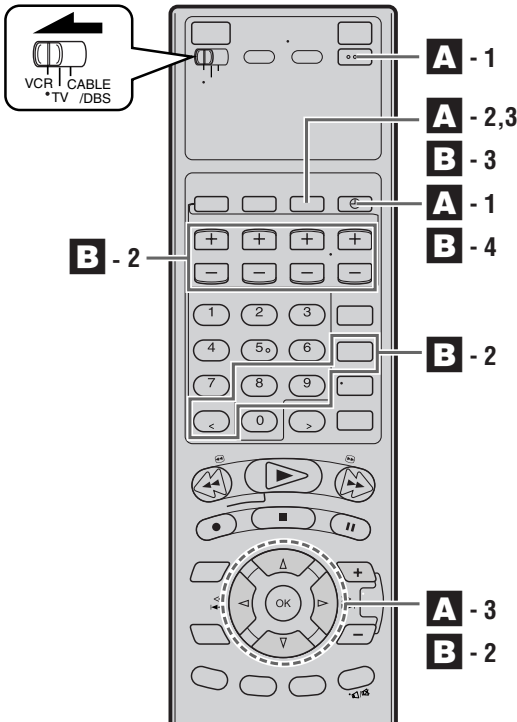

## A Checking program settings

### 1 Disengage timer

Press [TIMER (⊙)], then press [POWER].

- When “AUTO TIMER” (ⓘ page 66) is set to “ON”, you do not have to press [TIMER (⊙)].

### 2 Access Program List screen

Press [PROG. CHECK].

- The clock must be set to access the program list.
- If you have not set the clock, the Main Menu screen appears after an error message is displayed. Refer to page 17 for the clock setting procedure.

DATE	START-STOP	DAILYWEEKLY	CH	REC SPEED
3/31/04 (WED)	8:00PM - 10:00PM	EVERY WED	CATV12CH	STD (SP)
4/ 3/04 (SAT)	11:00PM - 11:45PM	MON-SAT	VCR47CH	STD (SP)
4/ 4/04 (SUN)	10:30PM - 11:45PM	SUN -SAT	DBS110CH	STD (SP)

SELECT WITH ARROW KEYS THEN PRESS [OK]

### 3 Access Program screen

Press [Δ▽] to select a program, then press [OK] to check more detailed information.

- To return to the normal screen, press [PROG. CHECK].

## B Canceling or changing program settings

### 1 Access Program screen

Repeat steps 1 to 3 in the left column.

### 2 Cancel or change program setting

To cancel a program, press [OK] with the arrow on “CANCEL”, then press [OK] with the arrow on “CONFIRM”.

OR

press [CANCEL], then press [OK].

- “PROGRAM CANCELED” appears on the screen, then press [OK] to return to the program list.

START TIME	STOP TIME	DATE	CH
8:00 PM	10:00 PM	3/31/04 (WED)	12 CH

REC SPEED	DAILYWEEKLY	SOURCE
STD (SP)	EVERY WED	CATV

SET PROGRAM WITH [←] [→] [REC SPEED], [D-DAILY, W-WEEKLY] THEN PRESS 'CONFIRM'

To change a program, press the appropriate button: [START+/-], [STOP+/-], [DATE+/-], [TV/VCR CH+/-], [DAILY] (number [8]), [WEEKLY] (number [9]) and/or [REC SPEED], then press [OK].

- “PROGRAM COMPLETED PRESS [TIMER] TO ENTER TIMER STANDBY MODE” appears on the screen, then press [OK] to return to the program list.

### 3 Return to normal screen

Press [PROG. CHECK].

### 4 Reengage timer recording standby mode

Press [TIMER (⊙)].

- When “AUTO TIMER” (ⓘ page 66) is set to “ON”, the timer recording standby mode automatically resumes when you turn off the VCR.

# Satellite Auto Recording

- Turn on the VCR and the TV, and select the AV mode on the TV.
- Set the [VCR/TV/CABLE/DBS] selector on the Remote to [VCR].

This function allows you to automatically record a satellite program which is timer-programmed on your DBS receiver.

**Preparation :** Connect a DBS receiver to the [AUDIO/VIDEO INPUT L-1] or [S VIDEO INPUT L-1] connectors\* on the rear; otherwise, you cannot use this function.

- You can also connect the cable box if it has a timer.

\* To use these connectors, you have to select which one to use (☞ page 66).

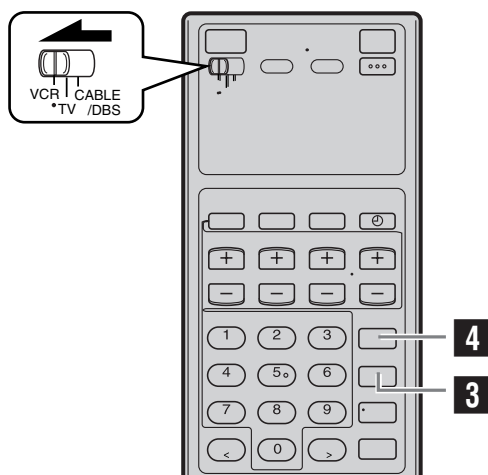

## 1 Set timer program on DBS receiver

- For timer programming method, refer to the manual supplied with the DBS receiver.

## 2 Load a cassette

Make sure the record safety tab is intact.

## 3 Set recording speed

Press [REC SPEED] to set the recording speed.

## 4 Engage Satellite Auto Recording standby mode

Turn off the DBS receiver.

Press and hold [REC LINK] on the Remote for more than 2 seconds.

The VCR turns off automatically, [⏸] and [⏻] appear on the front display panel (Satellite Auto Recording standby mode).

When the DBS receiver outputs a signal, the VCR starts recording and [⏸] blinks, the [⏻] and record [⏻] indicator light up. The VCR stops recording and powers off when the DBS receiver stops outputting a signal.

- This VCR will enter into Satellite Auto Recording standby mode after recording is finished.
- To release the Satellite Auto Recording standby mode, press [REC LINK]. [⏸] and [⏻] disappear.

### IMPORTANT:

Be sure not to turn on the DBS receiver before the program starts broadcasting; otherwise, the VCR will start recording when the DBS receiver is turned on.

### NOTES:

- While in the Satellite Auto Recording standby mode or after Satellite Auto Recording is finished, the VCR will not enter the timer recording standby mode even though "AUTO TIMER" is set to "ON" (☞ page 66).
- If you turn off this VCR while Satellite Auto Recording is in progress, recording stops.
- Video Calibration (☞ page 63) does not work while Satellite Auto Recording is in progress.
- Auto Clock (☞ page 18) does not work while in the Satellite Auto Recording standby mode.
- The VCR may not record a short portion at the beginning of the program or may record slightly longer than the actual length of the program when Satellite Auto Recording method is used.
- If you engage the Satellite Auto Recording standby mode while the DBS receiver is turned on, the VCR will not start Satellite Auto Recording, [⏸] on the front display panel blinks rapidly and [⏻] lights up. When you turn off the DBS receiver, [⏸] and [⏻] light up and the VCR enters the Satellite Auto Recording standby mode.
- If you have connected another component other than a DBS receiver (or cable box) to the [AUDIO/VIDEO INPUT L-1] or [S VIDEO INPUT L-1] connectors, be sure not to engage the Satellite Auto Recording standby mode; otherwise, the VCR will start recording when the connected component is turned on.
- Satellite Auto Recording and timer-recording cannot be performed at the same time.
- If the [⏸] blinks rapidly on the front display panel in the Satellite Auto Recording standby mode (even though your DBS receiver is turned off), Satellite Auto Recording will not work properly. If this is the case, perform 'Express Timer Programming' (☞ page 44) to timer-record a satellite program. (Some DBS receivers output signals even if the power is off. Satellite Auto Recording is not possible with those DBS receivers.)



# i.LINK Timer Programming

- Turn on the VCR and the TV (and/or Digital Set Top Box).
- Set the [VCR/TV/CABLE/DBS] selector on the Remote to [VCR].

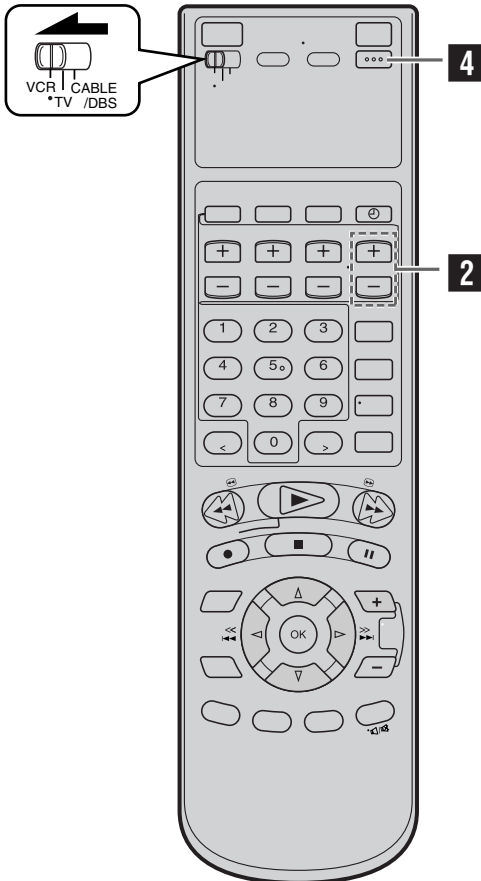
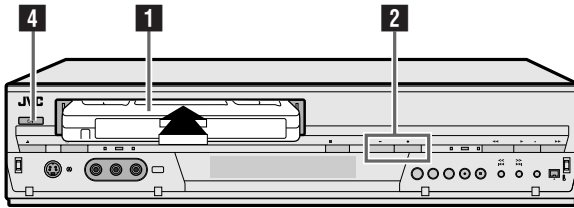

This VCR can perform D-VHS recording of a program which is timer-programmed on your Integrated HDTV (or Digital Set Top Box).

## 1 Load a D-VHS cassette

Make sure the record safety tab is intact. If not, cover the hole with adhesive tape before inserting the cassette.

- The [D-VHS] LED on the front panel and [D-VHS] indicator on the front display panel light up and the D-VHS recording mode is enabled.

## 2 Select recording channel (i.LINK input)

**On the front panel:**

Press [CHANNEL +] or [-] to select "I-1" etc.

**On the Remote:**

Press [TV/VCR CH +] or [-] to select "I-1" etc.

- Set "LINC" to "AUTO". (see page 70)

## 3 Set timer program on the Integrated HDTV source

- Confirm that a link has been established between this VCR and the Integrated HDTV.
- Set the recording speed to "AUTO" if this option is available.
- For timer programming method, refer to the manual of the Integrated HDTV.

## 4 Engage recording standby mode

Press [POWER] to turn off the VCR.

- The Integrated HDTV will activate the VCR to automatically start recording through i.LINK at the programmed time.
- The VCR may not record a short portion at the beginning of the program, to ensure full recording of the program, turn on the VCR slightly before the programmed time.

### ATTENTION:

When this VCR is connected via i.LINK to a TV or a Digital Set Top Box, there may be cases when the images are not recorded by the VCR. In such cases, choose the record command from the i.LINK menu of the TV or the Set Top Box.



# Video Remote Control Timer Programming

- Turn on the VCR and the TV (and/or Digital Set Top Box).
- Set the [VCR/TV/CABLE/DBS] selector on the Remote to [VCR].

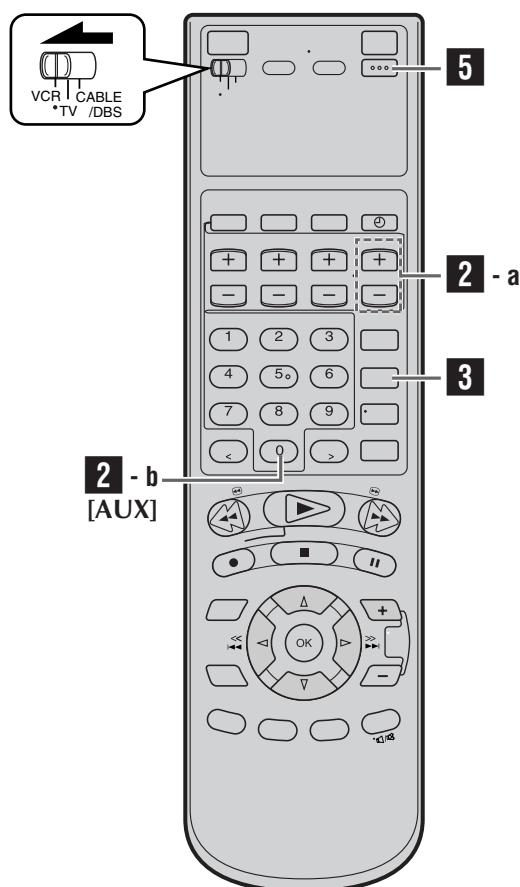
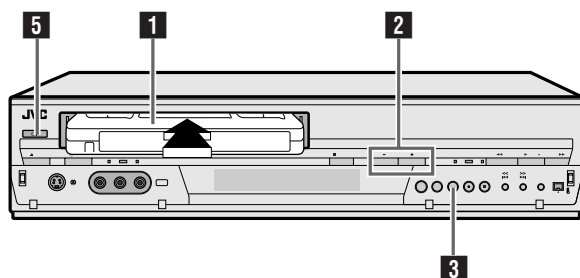

This VCR can perform analog recording of a program which is timer-programmed on your Integrated HDTV (or Digital Set Top Box).

## 1 Load a cassette

Make sure the record safety tab is intact. If not, cover the hole with adhesive tape before inserting the cassette.

## 2 Select analog input location on the VCR

**On the front panel:**

Press [CHANNEL +] or [-] to select "L-1" etc.

**On the Remote:**

- a- Press [TV/VCR CH +] or [-] to select "L-1" etc.
- or
- b- Press the 'Number' key [0(AUX)].

## 3 Set recording speed

Press [REC SPEED] to set the recording speed.

## 4 Set timer program on the Integrated HDTV

- For timer programming method, refer to the manual of the Integrated HDTV.

## 5 Engage recording standby mode

Press [POWER] to turn off the VCR.

- The Integrated HDTV will activate the VCR to automatically start recording through the Video Remote Controller at the programmed time.

**ATTENTION:**

- If there is a conflict in the timer schedule and one program overlaps with another, only the parts shown below in gray will be recorded.

**Pattern 1** : The program with the lower program number will be recorded.

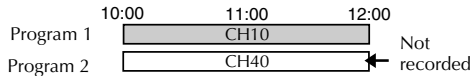

**Pattern 2** : The program starting earlier will be recorded.

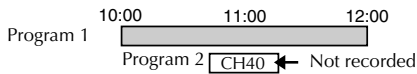

**Pattern 3** : The program starting earlier will be recorded, followed by the remaining portion of the other program.

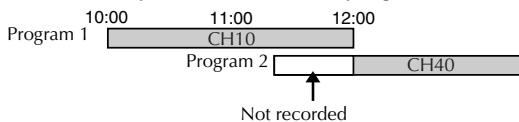

- When using i.LINK Timer Programming or Video Remote Control Timer Programming, if the program stop time of the Integrated HDTV (or Digital Set Top Box) coincides with the program start time of the VCR or vice versa, only the parts shown below in gray will be recorded.

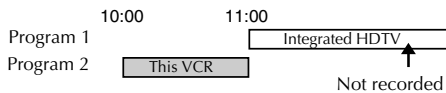
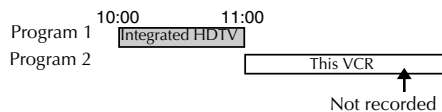
**NOTES:**

- During timer programming, try to set an interval of more than 1 minute between the program stop time of Program 1 and the program start time of Program 2 or vice versa.
- For the timer programming method, refer to the manual of the Integrated HDTV (or Digital Set Top Box).

**Other Useful functions for timer recording**

You can also use the following functions for timer recording.

- **“AUTO TIMER”** (☞ page 66)

When “AUTO TIMER” is set to “ON”, the timer recording standby mode is automatically engaged when the VCR is turned off. It is temporarily canceled when the VCR is turned on. You do not have to press [TIMER (Ⓢ)] to engage or disengage the timer recording standby mode.

- **“AUTO SP → EP TIMER”** (S-VHS/VHS only) (☞ page 66)

If there is not enough tape to record the entire broadcast for recording in SP mode, the VCR automatically switches to EP mode to allow complete recording. This feature is especially handy when recording a broadcast of more than 2 hours in length.

# Navigation Playback

- Turn on the VCR and the TV, and select the AV mode on the TV.
- Set the [VCR/TV/CABLE/DBS] selector on the Remote to [VCR].

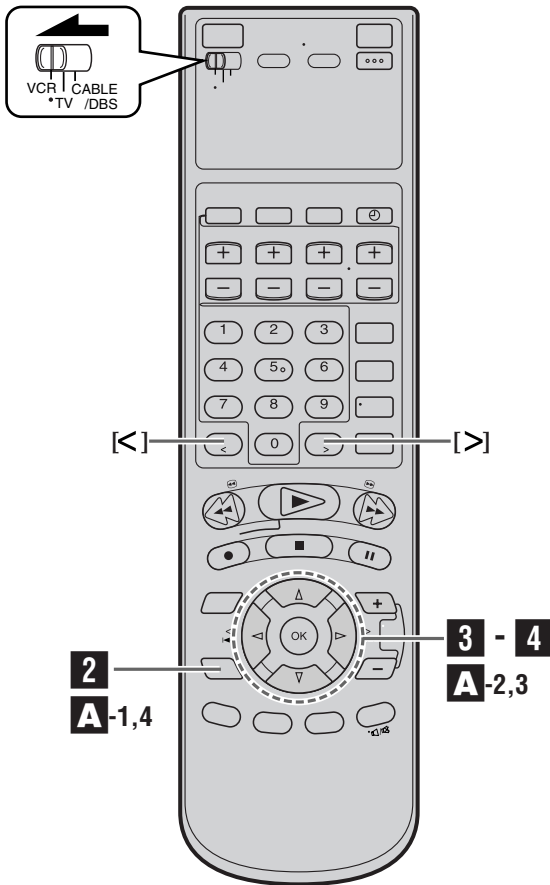

## 1 Load a cassette

Insert a tape recorded on this VCR.

- The VCR turns on automatically.
- The tape will run for a few seconds while the VCR searches for the tape number recorded. If tape number is found, it will be shown on the TV screen if "SUPERIMPOSE" is set to "ON" (see page 66).
- The counter is reset automatically, however, it is not completely reset to "0:00:00".
- If the cassette's record safety tab has been removed, playback begins automatically.

## 2 Access Video Navigation screen

Press [NAVI].

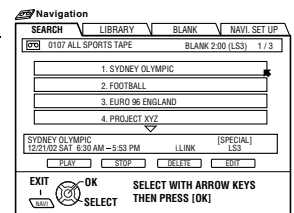

- After pressing [NAVI], it may take a few seconds to access the Title screen while the VCR searches for the Video Navigation information.

## 3 Select program

Press [ $\Delta$ / $\nabla$ ] to select the program you want to watch, then press [OK].  
To go to another page of the lists, press [<] or [>].

## 4 Start playback

Press [< >] to move the arrow to "PLAY", then press [OK].  
Playback starts automatically after the selected program is located.

### NOTES:

- If you press [NAVI] while Video Navigation is deactivated, the Navigation Set Up screen appears. Set "NAVIGATION" to "ON" (see page 52).
- Video Navigation playback is possible only with the tape recorded on this VCR.
- To record the date and time as the program title in this VCR's memory, make sure the VCR's clock is set correctly before recording.
- To record the program information in this VCR's memory, you must record each program for over the minimum recording time; 5 min for the D-VHS (HS) mode, 10 min for the D-VHS (STD) mode, 30 min for the D-VHS (LS3) mode, 5 min for the S-VHS/VHS (SP) mode and 15 min for S-VHS/VHS (EP) mode.
- Video Navigation may not work properly for some tapes.
- During playback or when searching for the beginning of a program, a VCR might find two different tape numbers recorded on a tape. After you remove this tape, the tape will be assigned just one tape number (the smaller one). After this, the higher tape number will be missing from the memory's tape number list.
- Tape program information is stored in this VCR's memory. If this VCR's memory is damaged and the program information is lost, it is impossible to restore that information.
- After recording a tape on this VCR, write the tape number on a label and affix the label to the tape in order to allow you to find the tape by its number.
- The on-screen display is output to the TV with S-VIDEO, VIDEO, COMPONENT VIDEO signal in 480i image format.

### How to read the Video Navigation screen

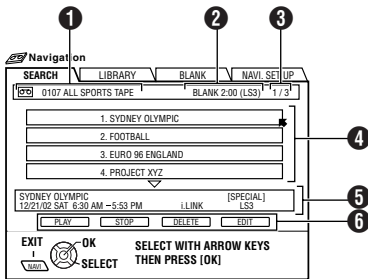

- ❶ Tape number and tape title
- ❷ Maximum blank time on the tape
- ❸ Page No./Total Page No. (only 4 programs can be shown at a time)
- ❹ Program title included on a tape
- ❺ The detailed program information currently selected (date, auxiliary input, category, start time, end time, recording speed)
- ❻ Operational commands

Example

SYDNEY OLYMPIC 8:00	BLANK 2:00	EURO 96 ENGLAND	BLANK 1:00
---------------------	------------	-----------------	------------

Blank part\* —————

\* "BLANK" appears for non-recorded part, the part whose information has been deleted manually (see page 61), or the part where new program has been recorded.

### How to read the Video Navigation screen for D-Theater tape\*

If you insert a D-Theater tape ([D-THEATER] LED lights up) and then press [NAVI], the following screen appears. Press [ $\Delta$   $\nabla$   $\leftarrow$   $\rightarrow$ ] to move the arrow to the item that you want to watch, then press [OK]. Playback starts automatically after the selected item is located.

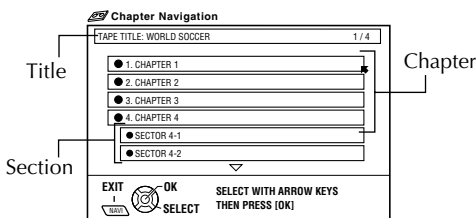

\* D-Theater is a technical specification based on D-VHS standards that was developed for HD content. Commercial D-Theater titles can only be played back on D-VHS digital recorders bearing the D-Theater logo.

## A Deactivating Video Navigation

If you do not want to store program information, you can deactivate the Video Navigation function.

### 1 Access Video Navigation screen

Press [NAVI].

### 2 Access Navigation Set Up screen

Press [ $\Delta$   $\nabla$   $\leftarrow$   $\rightarrow$ ] to move the arrow to "NAVI. SET UP", then press [ $\nabla$ ] or [OK].

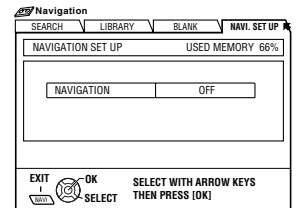

### 3 Deactivate Video Navigation

Press [ $\leftarrow$   $\rightarrow$ ].

- Each time you press [ $\leftarrow$   $\rightarrow$ ], Video Navigation turns "ON" or "OFF".

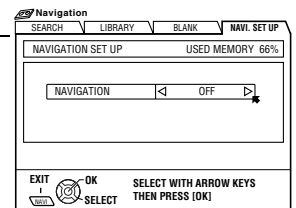

### 4 Return to normal screen

Press [NAVI].

#### NOTE:

If you press [NAVI] when a cassette is not loaded, "NO TAPE!" appears on the TV screen. If the VCR does not recognize the tape number of the loaded cassette, "UNRECOGNIZED TAPE NUMBER!" appears on the TV screen.

# Finding Tapes

- Turn on the VCR and the TV, and select the AV mode on the TV.
- Set the [VCR/TV/CABLE/DBS] selector on the Remote to [VCR].

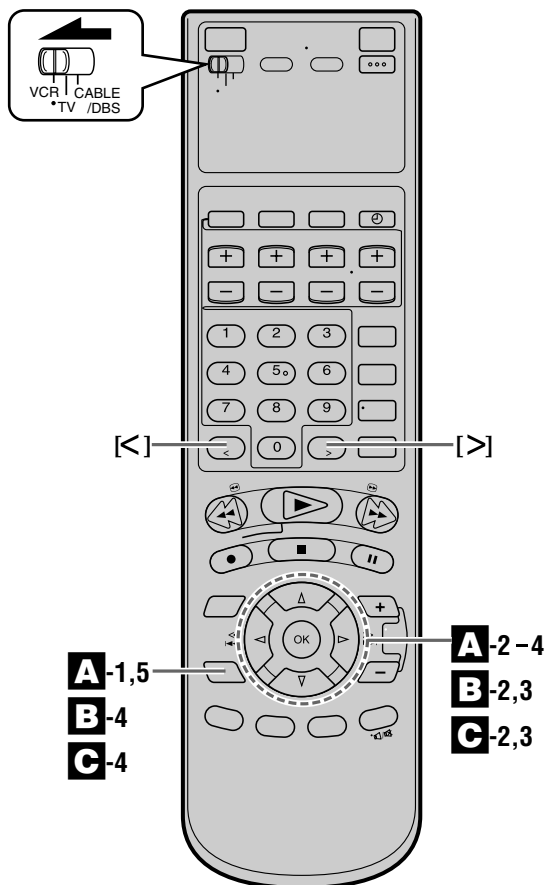

**A**-1,5  
**B**-4  
**C**-4

**A**-2-4  
**B**-2,3  
**C**-2,3

## To play back a selected program on the list screen

- 1 Select the program that you want to watch, then press [OK].
- 2 Insert the corresponding tape.
- 3 Press [OK] again with the arrow on "SEARCH".
- 4 Confirm that the desired program is highlighted, then press [OK].
  - Playback starts automatically after the selected program is located.

You can find a tape you want using Video Navigation. You have four methods to find tapes; by tape number, by program title, by category, by recording date, and by tape remaining time.

## **A** Finding by tape number

Use the Remote to do the following operations.

### 1 Access Video Navigation screen

Press [NAVI].

### 2 Access Library screen

Press [Δ▽◀▶] to move the arrow to "LIBRARY", then press [▽] or [OK].

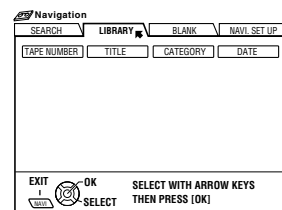

### 3 Access tape number list screen

Press [◀▶] to move the arrow to "TAPE NUMBER", then press [OK].

The tape number list screen appears, being sorted by the tape numbers.

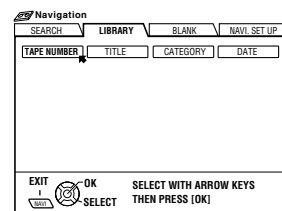

### 4 Confirm tape number lists

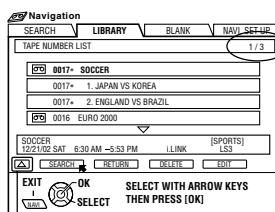

1st page (out of 3 pages in this example) of the tape number lists is shown.

switch for changing the order

- "1/3" is displayed beside the tape number of the loaded cassette.
- The cassette mark is displayed on the left of the tape title. The items without the cassette marks are the program titles included in the tape.
- To go to another page of the lists, press [◀] or [▶].
- To play back the desired program, refer to 'To play back a selected program on the list screen' in the left column.

### 5 Return to normal screen

Press [NAVI].

## B Finding by program title

Use the Remote to do the following operations.

**1** Follow steps 1 to 2 on page 53, then go to the following steps

**2** Access title screen

Press [ $\triangleleft$   $\triangleright$ ] to move the arrow to "TITLE", then press [OK].

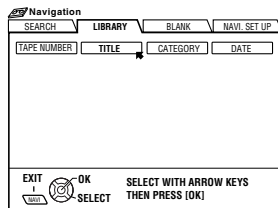

**3** Confirm lists

- "\*" is displayed beside the tape number of the loaded cassette.
- The cassette mark is displayed on the left of the tape title. The items without the cassette marks are the program titles included in the tape.
- To go to another page of the lists, press [ $\triangleleft$ ] or [ $\triangleright$ ].
- To play back the desired program, refer to 'To play back a selected program on the list screen' on page 53.

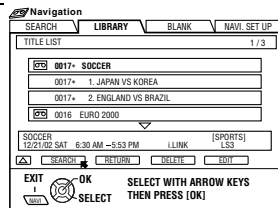

**4** Return to normal screen

Press [NAVI].

## C Finding by category

Use the Remote to do the following operations.

To find a program by category, be sure to select program category in advance (see page 60).

**1** Follow steps 1 to 2 on page 53, then go to the following steps

**2** Access category screen

Press [ $\triangleleft$   $\triangleright$ ] to move the arrow to "CATEGORY", then press [OK].

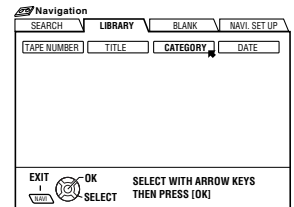

**3** Confirm lists

- "\*" is displayed beside the tape number of the loaded cassette.
- The cassette mark is displayed on the left of the tape title. The items without the cassette marks are the program titles included in the tape.
- To go to another page of the lists, press [ $\triangleleft$ ] or [ $\triangleright$ ].
- To play back the desired program, refer to 'To play back a selected program on the list screen' on page 53.

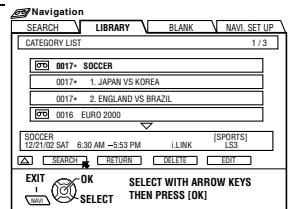

**4** Return to normal screen

Press [NAVI].

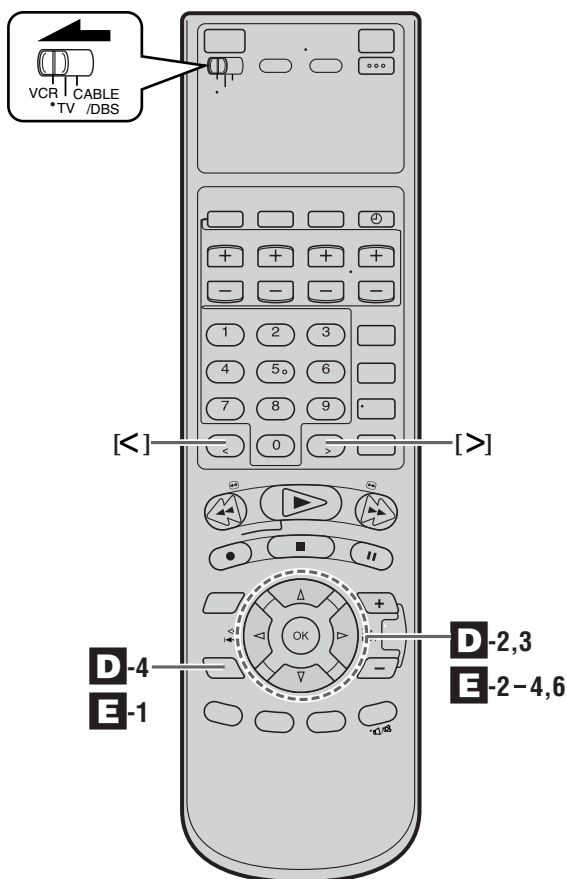

## D Finding by recording date

Use the Remote to do the following operations.

**1** Follow steps 1 to 2 on page 53, then go to the following steps

**2** Access date screen

Press [**<**] to move the arrow to "DATE", then press [OK]. The list screen appears, being sorted by the recording date.

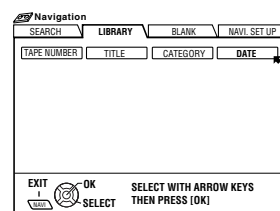

**3** Confirm lists

- "\*" is displayed beside the tape number of the loaded cassette.
- The cassette mark is displayed on the left of the tape title. The items without the cassette marks are the program titles included in the tape.
- To go to another page of the lists, press [**<**] or [**>**].
- To play back the desired program, refer to 'To play back a selected program on the list screen' on page 53.

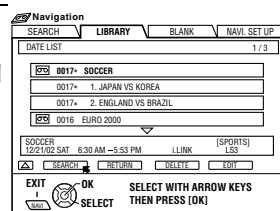

**4** Return to normal screen

Press [NAVI].

## **E** Finding blank space

You can find a tape whose remaining time is enough for a program you want to record.

Use the Remote to do the following operations.

### 1 Access Video Navigation screen

Press [NAVI].

### 2 Access Blank Space List screen

Press [ $\Delta$ ▽◀ ▶] to move the arrow to "BLANK", then press [▽] or [OK].

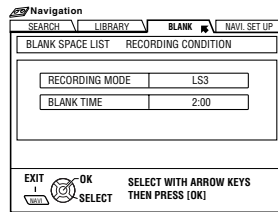

### 3 Set condition

Press [ $\Delta$ ▽] to move the arrow to "RECORDING MODE", then press [◀ ▶] to select the recording speed. Press [ $\Delta$ ▽] to move the arrow to "BLANK TIME", then press [◀ ▶] to select the blank time. Then press [OK].

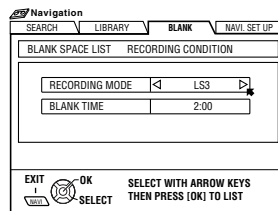

### 4 Select tape number

Press [ $\Delta$ ▽], then press [OK].

- To go to another page of the lists, press [◀] or [▶].

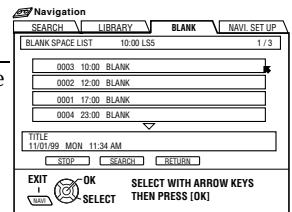

### 5 Load a cassette

Insert the cassette whose number you have found in step 4.

### 6 Select blank

Press [◀ ▶] to move the arrow to "STOP", then press [OK].

- The VCR will start search for the beginning of the blank part, then stop.

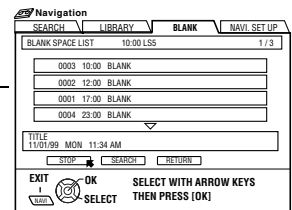

### 7 Prepare for recording

See page 35 for recording.



# Editing Titles

- Turn on the VCR and the TV, and select the AV mode on the TV.
- Set the [VCR/TV/CABLE/DBS] selector on the Remote to [VCR].

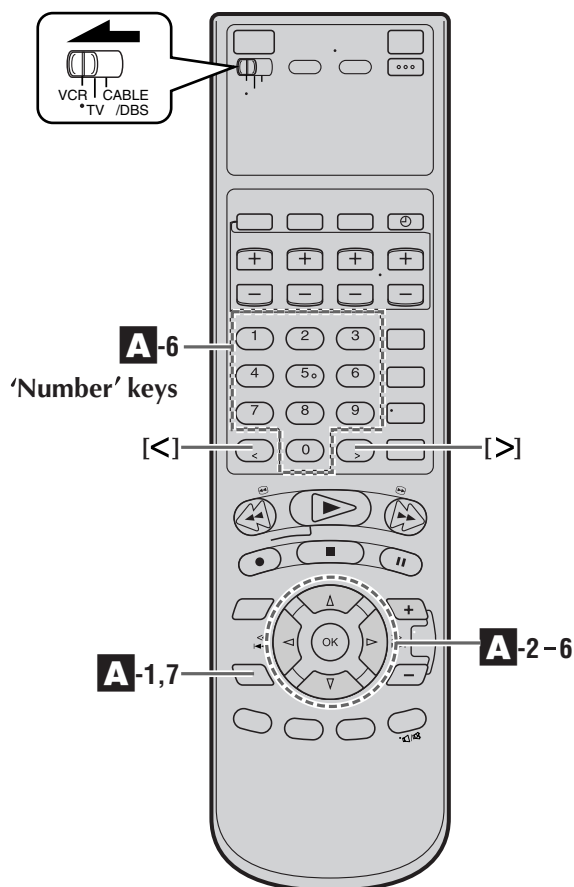

When you record a TV program on this VCR, the VCR automatically records the recording start time, date, and channel in each program title. If the tape is recorded for the first time, the tape number and the date and time are recorded in the tape title. You can then edit the tape title and the program titles as you like. You can also edit the category in the program title.

In short, you can use the Video Navigation function to create your own video tape library.

## A Editing tape title

When you want to edit the tape title, follow the procedure below by using the Remote.

### 1 Access Video Navigation screen

Press [NAVI].

### 2 Access Library screen

Press [ $\Delta$   $\nabla$   $\triangleleft$   $\triangleright$ ] to move the arrow to "LIBRARY", then press [ $\nabla$ ] or [OK].

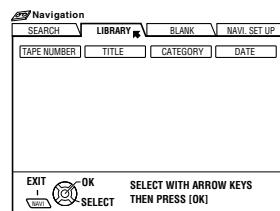

### 3 Access tape number list screen

Press [ $\triangleleft$   $\triangleright$ ] to move the arrow to "TAPE NUMBER", then press [OK].

The tape number list screen appears, being sorted by the tape numbers.

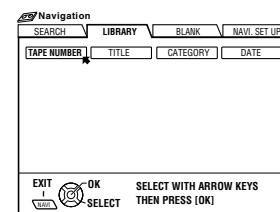

### 4 Select tape number

Press [ $\Delta$   $\nabla$ ] to select the tape number for which you want to edit the title, then press [OK].

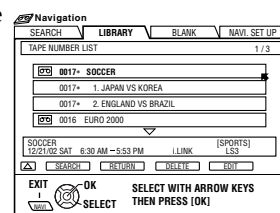

- "\*" is displayed beside the tape number of the loaded cassette.
- The cassette mark is displayed on the left of the tape title. The items without the cassette marks are the program titles included in the tape.
- To go to another page of the lists, press [ $\triangleleft$ ] or [ $\triangleright$ ].

## 5 Access edit screen

Press [ $\triangleleft$   $\triangleright$ ] to move the arrow to "EDIT", then press [OK].

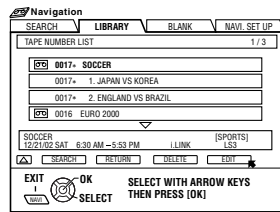

## 6 Enter title

- 1 Press [ $\triangle$   $\nabla$   $\triangleleft$   $\triangleright$ ] to move the arrow on the desired character or symbol, then press [OK].

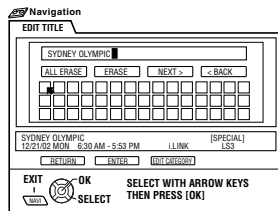

OR

Press the 'Number' keys to enter the title.

- For entering the characters as the title, refer to 'How to enter the characters and symbols' on the right column. (In this example, enter "JVC NEWS".)
- 2 Press [ $\triangle$   $\nabla$   $\triangleleft$   $\triangleright$ ] to move the arrow to "ENTER", then press [OK].

## 7 Return to normal screen

Press [NAVI].

### How to enter the characters and symbols with the number keys on the Remote

Press the 'Number' keys, then press [ $\triangleright$ ] to enter each character. Refer to the example below.

#### (E.g.) Enter "JVC NEWS".

- 1 Press [5 (JKL)] once to enter "J", then press [ $\triangleright$ ].
- 2 Press [8 (TUV)] three times to enter "V", then press [ $\triangleright$ ].
- 3 Press [2 (ABC)] three times to enter "C", then press [ $\triangleright$ ].
- 4 Press [0 (-)] twice to enter "- (space)", then press [ $\triangleright$ ].
- 5 Press [6 (MNO)] twice to enter "N", then press [ $\triangleright$ ].
- 6 Press [3 (DEF)] twice to enter "E", then press [ $\triangleright$ ].
- 7 Press [9 (WXYZ)] once to enter "W", then press [ $\triangleright$ ].
- 8 Press [7 (PQRS)] four times to enter "S", then press [ $\triangleright$ ].

NUMBER KEY	CHARACTERS
1	. , ? - + * / [ ] 1
2	A B C a b c 2
3	D E F d e f 3
4	G H I g h i 4
5	J K L j k l 5
6	M N O m n o 6
7	P Q R S p q r s 7
8	T U V t u v 8
9	W X Y Z w x y z 9
0	0 _ (space)

### NOTES:

- If you want to delete a character, select the character, then press [CLEAR] or press [OK] with the arrow on "ERASE".
- If you want to delete all characters, press [OK] with the arrow on "ALL ERASE".

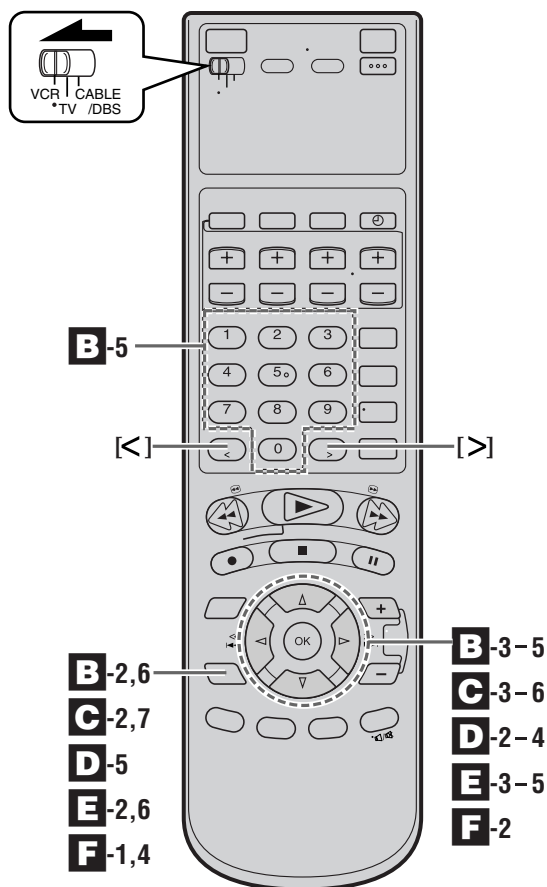

## B Entering or Editing program title

When you want to edit the program title, follow the procedure below by using the Remote.

### 1 Load a cassette

Insert a tape on which there is a program you want to edit.

### 2 Access Video Navigation screen

Press [NAVI].

### 3 Select program

Press [ $\Delta$ ▽] to select the program you want to edit, then press [OK].

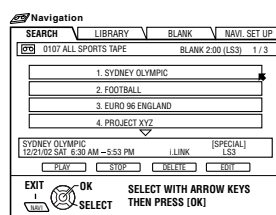

### 4 Access edit screen

Press [ $\Delta$ ▽] to move the arrow to "EDIT", then press [OK].

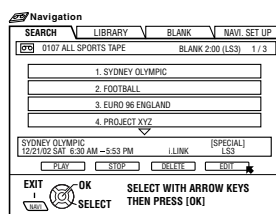

### 5 Enter title

1 Press [ $\Delta$ ▽< >] to move the arrow on the desired character or symbol, then press [OK].

OR

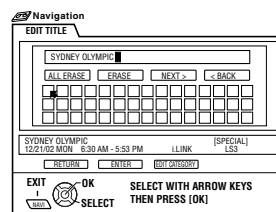

Press the 'Number' keys to enter the title.

- For entering the characters as the title, refer to 'How to enter the characters and symbols' on page 58. (In this example, enter "JVC NEWS".)

2 Press [ $\Delta$ ▽< >] to move the arrow to "ENTER", then press [OK].

### 6 Return to normal screen

Press [NAVI].

## C Editing program category

When you want to change the program category, follow the procedure below by using the Remote.

### 1 Load a cassette

Insert a tape on which there is a program you want to edit.

### 2 Access Video Navigation screen

Press [NAVI].

### 3 Select program

Press [ $\Delta$   $\nabla$ ] to select the program you want to edit, then press [OK].

### 4 Access edit screen

Press [ $\leftarrow$   $\rightarrow$ ] to move the arrow to "EDIT", then press [OK].

### 5 Access category screen

Press [ $\Delta$   $\nabla$   $\leftarrow$   $\rightarrow$ ] to move the arrow to "EDIT CATEGORY", then press [OK].

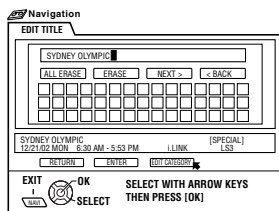

### 6 Select category

Press [ $\Delta$   $\nabla$   $\leftarrow$   $\rightarrow$ ] to select the category you want, then press [OK].

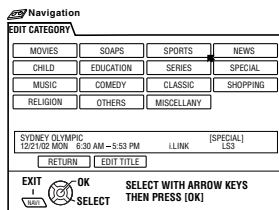

### 7 Return to normal screen

Press [NAVI].

## D Deleting tape information

When you want to delete the entire tape information (information for all recorded programs on the tape), follow the procedure below by using the Remote.

- Tape information for the Video Navigation function is deleted, but the recorded programs will not be erased.

### ATTENTION:

Once the information is deleted, it is impossible to restore that information.

### 1 Follow steps 1 to 3 on page 57, then go to the following steps

### 2 Select tape number

Press [ $\Delta$   $\nabla$ ] to select the tape number for which you want to edit the title, then press [OK].

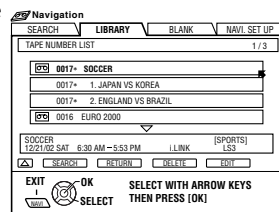

- "\*" is displayed beside the tape number of the loaded cassette.
- The cassette mark is displayed on the left of the tape title. The items without the cassette marks are the program titles included in the tape.
- To go to another page of the lists, press [ $\leftarrow$ ] or [ $\rightarrow$ ].

### 3 Access delete screen

Press [ $\leftarrow$   $\rightarrow$ ] to move the arrow to "DELETE", then press [OK].

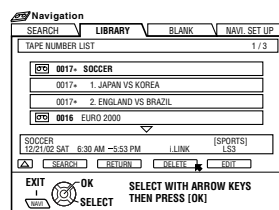

### 4 Delete tape information

Press [ $\leftarrow$   $\rightarrow$ ] to move the highlight bar to "YES", then press [OK].

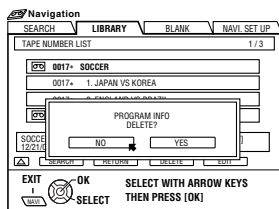

### 5 Return to normal screen

Press [NAVI].

## E Deleting program information

When you want to delete the stored information for each recorded program, follow the procedure below by using the Remote.

- Program information for the Video Navigation function is deleted, but the recorded program will not be erased.

### ATTENTION:

Once the information is deleted, it is impossible to restore that information.

### 1 Load a cassette

Insert a tape on which there is a program you want to edit.

### 2 Access Video Navigation screen

Press [NAVI].

### 3 Select program

Press [ $\Delta$   $\nabla$ ] to select the program you want to edit, then press [OK].

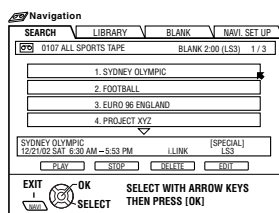

- “\*” is displayed beside the tape number of the loaded cassette.
- The cassette mark is displayed on the left of the tape title. The items without the cassette marks are the program titles included in the tape.
- To go to another page of the lists, press [ $\leftarrow$ ] or [ $\rightarrow$ ].

### 4 Access delete screen

Press [ $\leftarrow$   $\rightarrow$ ] to move the arrow to “DELETE”, then press [OK].

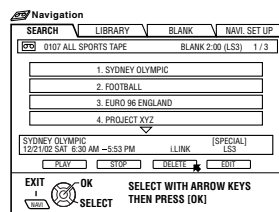

### 5 Delete program information

Press [ $\leftarrow$   $\rightarrow$ ] to move the highlight bar to “YES”, then press [OK].

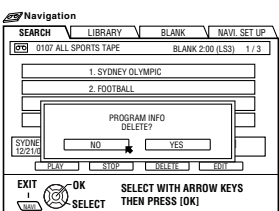

### 6 Return to normal screen

Press [NAVI]

## F Checking memory

You can check the amount of recorded information in the VCR's memory.

### 1 Access Video Navigation screen

Press [NAVI].

### 2 Access Navigation Set Up screen

Press [ $\Delta$   $\nabla$   $\leftarrow$   $\rightarrow$ ] to move the arrow to “NAVI. SET UP”.

### 3 Check memory

The percentage of the used memory is displayed.

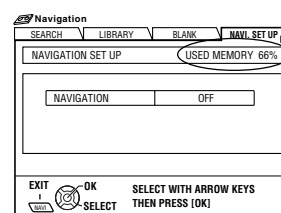

### 4 Return to normal screen

Press [NAVI].

If memory is full, you have to delete unwanted information to store more information in the VCR's memory.

# Useful Function Settings

- Turn on the VCR and the TV, and select the AV mode on the TV.
- Set the [VCR/TV/CABLE/DBS] selector on the Remote to [VCR].

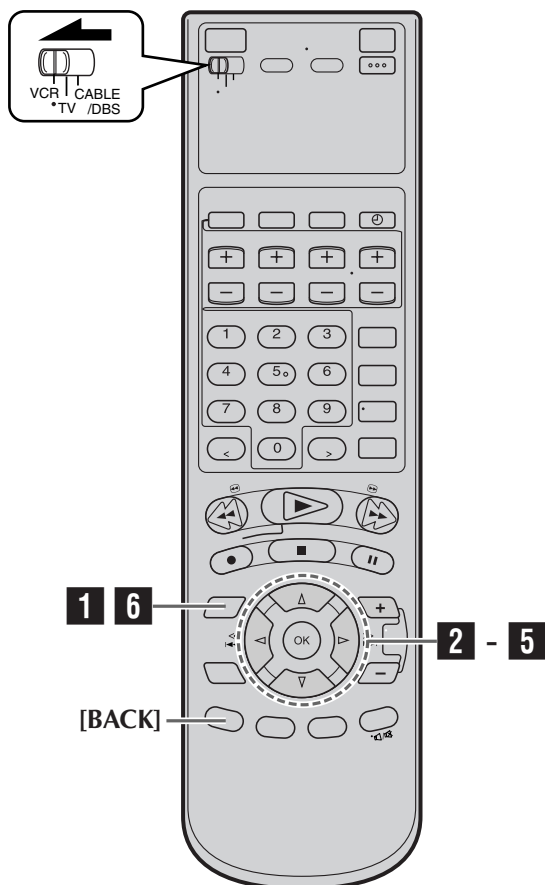

You can use the other useful function settings on the Function Set Up screens by following the procedure described below.

The table below shows the structure of the menu system.

<b>"FUNCTION SET UP"</b>	"VIDEO FUNCTION" (☞ page 63) "AUDIO FUNCTION" (☞ page 64) "IN/OUT FUNCTION" (☞ page 65) "ADDITIONAL" (☞ page 66)
--------------------------	---

- For the functions you can set on the Function Set Up screen, see pages 63 to 68.

## 1 Access Main Menu screen

Press [MENU].

## 2 Access Function Set Up screen.

Press [◀ ▶] to move the arrow to "FUNCTION SET UP", then press [▽] or [OK].

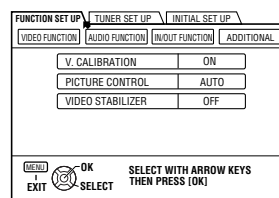

## 3 Select Function Menu

Press [◀ ▶] to move the arrow to the menu of the function you want to set, then press [▽] or [OK].

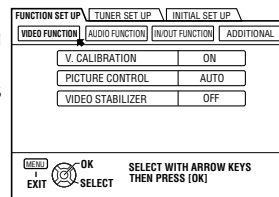

## 4 Select Function

Press [△▽] to move the arrow to the function you want to set.

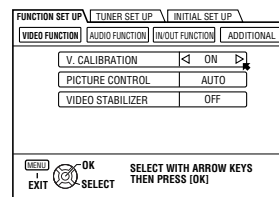

## 5 Change setting

Press [◀ ▶].

## 6 Return to normal screen

Press [MENU].

### NOTE:

To go back to a previous screen during settings, press [BACK].

## Video settings “VIDEO FUNCTION”

\*The default setting is **bold** in the table below.

<p>■ <b>“V. CALIBRATION”</b> (S-VHS/VHS only) “ON” “OFF”</p>	<p>When this function is set to “ON”, this VCR checks the condition of the tape in use during playback and recording, and compensates to provide the highest-possible pictures. This takes place whenever you play back a tape or start recording after inserting a tape.</p> <p><b>NOTES:</b></p> <ul style="list-style-type: none"> <li>• During playback, this function is always working even though “VIDEO CALIBRATION” appears just at the beginning of automatic tracking.</li> <li>• During recording, this function works only for the first SP recording and the first EP recording on an inserted tape. For timer recording, this function checks the tape condition both for the SP recording and the EP recording before the first timer recording starts.</li> <li>• When you play back rental tapes or tapes recorded on other VCRs, set this function either “ON” or “OFF” whichever gives you the best picture.</li> </ul>
<p>■ <b>“PICTURE CONTROL”</b> (S-VHS/VHS only) “AUTO” (“NORM”) “EDIT” “SOFT” “SHARP”</p>	<p>This function helps you to adjust the playback picture quality according to your preference.</p> <p><b>“AUTO”</b> : Normally select this. Picture quality is adjusted automatically. <b> (“NORM”)</b> When “V. CALIBRATION” is “OFF”, “NORM” will appear instead of “AUTO”. The quality is not adjusted automatically when “NORM” appears.</p> <p><b>“EDIT”</b> : Minimizes picture degradation during editing (recording and playback). <b>“SOFT”</b> : Reduces image coarseness when viewing overplayed tapes containing much noise. <b>“SHARP”</b> : Clearer, sharper-edged picture when viewing images with much flat, same-colored surfaces such as cartoons.</p> <p><b>NOTES:</b></p> <ul style="list-style-type: none"> <li>• When you select “EDIT”, “SOFT” or “SHARP”, the selected mode will not change until you select again.</li> <li>• Select “EDIT” when you are editing tapes (see page 74). After you finish editing the tapes, select “AUTO” (“NORM” when “V. CALIBRATION” is “OFF”).</li> </ul>
<p>■ <b>“VIDEO STABILIZER”</b> (S-VHS/VHS only) “ON” “OFF”</p>	<p>When this function is set to “ON”, you can correct vertical vibrations in the picture when playing back unstable recordings made on another VCR. This function is available only when playing back tapes recorded in EP mode.</p> <p><b>NOTES:</b></p> <ul style="list-style-type: none"> <li>• When you finish viewing a tape, be sure to set this function to “OFF”.</li> <li>• Regardless of the setting, this function has no effect during recording and during special effects playback.</li> <li>• To watch recordings with close-caption, set this function to “OFF”.</li> <li>• When this function is set to “ON”, the vertical vibrations may occur. Press [CHANNEL +] or [-] on the VCR (or [TV/VCR CH +] or [-] on the Remote) to eliminate vibration.</li> </ul>

# Audio settings "AUDIO FUNCTION"

\*The default setting is **bold** in the table below.

<p>■ <b>"STD AUDIO REC MODE"</b>          "STANDARD"  <b>"PCM&amp;STANDARD"</b></p>	<p>You can select the audio format when you record a program or analog signal from connected devices in STD mode. When this function is set to "PCM&amp;STANDARD", you can obtain high-quality audio sound.</p> <p>"STANDARD" : Select this when the picture quality is important and when you record in MP2 format.</p> <p><b>"PCM&amp;STANDARD"</b> : Select this when the sound quality is important. When you record the analog signals or DV signals from the camcorder in STD mode, PCM audio is also recorded in addition to MP2 audio. In HS mode, PCM audio is automatically recorded.</p>
<p>■ <b>"DV AUDIO REC"</b>  <b>"AUDIO1"</b>  <b>"AUDIO2"</b>  <b>"1+2MIX"</b></p>	<p>Up to four audio signal channels can be input from a DV camcorder through the DV IN connector (i.LINK). This VCR allows you to select and record two of these channels. This setting is used to specify which two channels to record.</p> <p><b>When there are four DV audio channels (32 kHz):</b></p> <p>"AUDIO1" : Records the two channels (L/R) of DV AUDIO 1.          "AUDIO2" : Records the two channels (L/R) of DV AUDIO 2.          "1+2MIX" : Mixes and records both DV AUDIO 1 and 2.</p> <p><b>When there are two DV audio channels (48 kHz):</b>          Because there are only two channels, those two channels are recorded regardless of the DV sound setting.</p>
<p>■ <b>"OPTICAL OUT"</b>  <b>"Dolby D"</b>  <b>"2CH-PCM"</b>  <b>"STREAM"</b></p>	<p>This VCR can send the Dolby Digital bitstream or PCM Audio to external devices. When you play back a tape including the Dolby Digital bitstream, and if you have a device equipped with Dolby Digital decoder, set this function to "Dolby D". If not, set this function to "2CH-PCM". "STREAM" will be used when you play back a tape including the DTS bitstream, and if you have a device with built-in DTS, or when playing back and receiving audio signals in other new formats.</p>

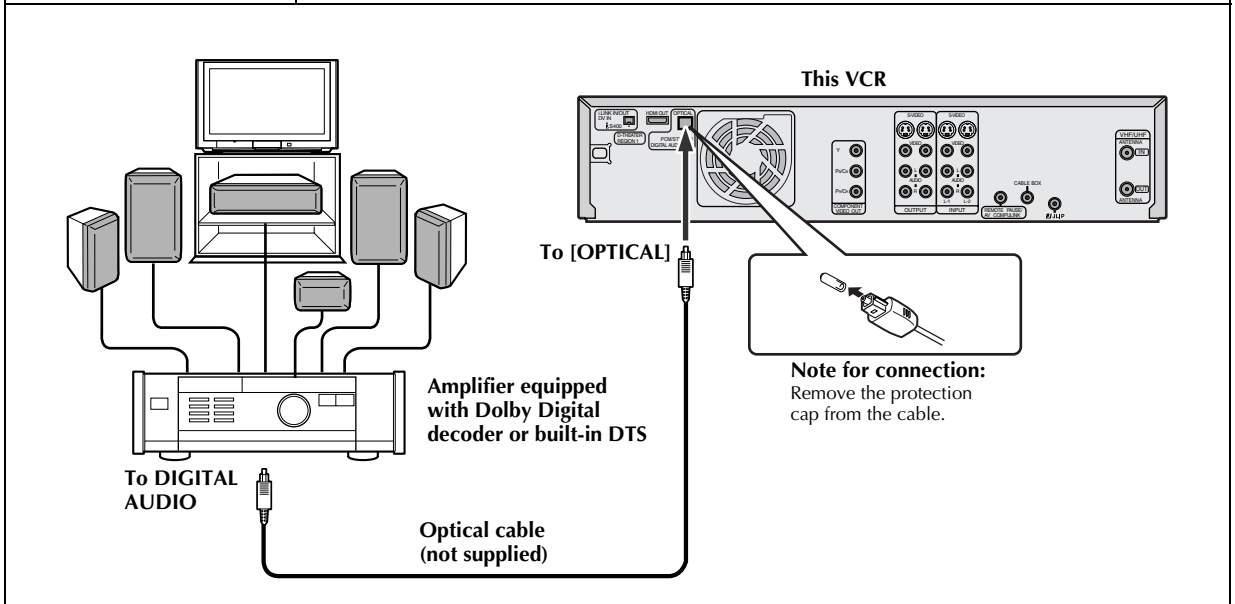

<p>■ <b>"2ND AUDIO REC"</b>  <b>"ON"</b>  <b>"OFF"</b></p>	<p><b>When this function is set to "ON";</b></p> <ul style="list-style-type: none"> <li>• If a SAP program is received, the SAP audio is recorded on both the normal and Hi-Fi tracks. The main audio is not recorded.</li> <li>• If a non-SAP program is received, the main audio is recorded on both the Hi-Fi and normal tracks.</li> </ul> <p><b>When this function is set to "OFF",</b> the SAP audio cannot be recorded.</p>
--	--



## Input/Output settings “IN/OUT FUNCTION”

\*The default setting is **bold** in the table below.

<p>■ <b>“TV OUTPUT 1”</b>  <b>“WIDE 16:9”</b>  “NORMAL 4:3”</p>	<p>Select the appropriate mode depending on the type of TV you have.  <b>“WIDE 16:9”</b> : Select this for a wide TV set with 16:9 screen image size.  <b>“NORMAL 4:3”</b> : Select this for a TV set with 4:3 screen image size.</p> <p><b>NOTES:</b></p> <ul style="list-style-type: none"> <li>• When “TV OUTPUT 1” is set to “WIDE 16:9”, sometimes the screen image may be stretched vertically.</li> <li>• When “TV OUTPUT 1” is set to “NORMAL 4:3”, sometimes subtitles may not be visible or the ends of the screen image may be cut off. Normally select “WIDE16:9”.</li> <li>• In order to let the equipment determine the screen image size, it is recommended that you connect the VCR and TV using the [COMPONENT VIDEO OUTPUT] connectors or [S VIDEO OUTPUT] connector.</li> <li>• This function is invalid if HDMI is activated.</li> </ul>
<p>■ <b>“TV OUTPUT 2”</b>  <b>“720to1080”</b>  “NO CONV.”  “ALLto480i”  “ALLto480p”</p>	<p>Select the appropriate mode when receiving signals via i.LINK connector or playing back a D-VHS tape containing a recording of an HD (High Definition) signal.  <b>“720to1080”</b> : 720p is up-converted to 1080i and output to the TV. 1080i, 480p, and 480i image formats are output to the TV without being converted. Select this when the 720p image played back is distorted.  <b>“NO CONV.”</b> : 1080i, 720p, 480p, and 480i image formats are output to the TV just as they are.  <b>“ALLto480i”</b> : All images will be output to the TV in 480i image format.  <b>“ALLto480p”</b> : All images will be output to the TV in 480p image format.</p> <p><b>NOTES:</b></p> <ul style="list-style-type: none"> <li>• When you receive signals via i.LINK connector or play back the picture of 1080i, 720p, 480p image format, the signal is not output from the [S-VIDEO] or [VIDEO] output connector if “TV OUTPUT 2” is set to “720to1080” or “NO CONV.”.</li> <li>• The progressive mode indicator [P] on the front display panel will light up when “ALLto480p” is selected.</li> <li>• If your TV supports only 480i image format and “ALLto480p” mode is previously selected, you can forcibly change the mode to “ALLto480i” by pressing and holding [PAUSE (II)] on the front panel for more than 5 seconds during power off mode.</li> <li>• During DV input, the image format output to the TV will be 480i even if this function is set to “ALLto480p”. However, the menu setting is retained and changes can be made.</li> <li>• If you cannot see the pictures on the TV screen when you play back a tape, set “TV OUTPUT 2” to the appropriate mode.</li> <li>• This function is invalid if HDMI is activated.</li> </ul>
<p>■ <b>“480i to 480p”</b>  <b>“ON”</b>  <b>“OFF”</b></p>	<p>When this function is set to “ON”, progressive output is being selected. The 480i image format is up-converted to 480p and output to the TV. The progressive mode indicator [P] on the front display panel will light up.</p> <p><b>NOTES:</b></p> <ul style="list-style-type: none"> <li>• When “TV OUTPUT 2” is set to “ALLto480i”, the image format being output to the TV will be 480i even if this function is set to “ON”.</li> <li>• During DV input, the image format output to the TV will be 480i even if this function is set to “ON”. However, the menu setting is retained and changes can be made. If you are using a TV with DVI input, and it does not support 480i image format, use the TV’s analog input instead.</li> <li>• This function is invalid if HDMI is activated.</li> </ul>
<p>■ <b>“HDMI to DVI COLOR”</b>  <b>“STANDARD”</b>  “ENHANCE”</p>	<p>When this VCR is connected to the TV via the DVI connection through [HDMI OUT] connector, this function allows you to select the desired deeper color intensity and to tone down the black color of the picture.</p>
<p>■ <b>“HDMI OUTPUT”</b>  <b>“AUTO”</b>  “RGB FIX”</p>	<p>Set this function to “RGB FIX” when the output from the [HDMI OUT] connector cannot be properly displayed on the TV screen.</p>
<p>■ <b>“FRONT AUX F-1”</b>  <b>“VIDEO”</b>  “S-VIDEO”</p>	<p>You have to select which terminal - either [VIDEO] (composite) or [S-VIDEO] (Y/C separate signals) to use as the video input terminal on the front panel.</p> <p>Make sure to select the correct terminal; otherwise, you may fail in recording (editing) on this VCR.</p>

\*The default setting is **bold** in the table below.

<p>■ <b>“REAR AUX L-1”</b>  <b>“VIDEO”</b>  “S-VIDEO”</p>	<p>You have to select which terminal - either [VIDEO] (composite) or [S VIDEO] (Y/C separate signals) to use as the video input terminal [L-1] on the rear panel.</p> <p>Make sure to select the correct terminal; otherwise, you may fail in recording (editing) on this VCR.</p>
<p>■ <b>“REAR AUX L-2”</b>  <b>“VIDEO”</b>  “S-VIDEO”</p>	<p>You have to select which terminal - either [VIDEO] (composite) or [S VIDEO] (Y/C separate signals) to use as the video input terminal [L-2] on the rear panel.</p> <p>Make sure to select the correct terminal; otherwise, you may fail in recording (editing) on this VCR.</p>

## Additional settings “ADDITIONAL”

\*The default setting is **bold** in the table below.

<p>■ <b>“AUTO SP → EP  TIMER”</b>  <b>(S-VHS/VHS only)</b>  “ON”  <b>“OFF”</b></p>	<p>When this function is set to “ON”, the VCR automatically switches to EP mode to allow complete recording if there is not enough tape to record the entire program while timer-recording in SP mode.</p> <p><b>For Example . . .</b>  Recording a program of 140 minutes in length onto a 120-minute tape</p> <table style="margin-left: auto; margin-right: auto; border-collapse: collapse;"> <tr> <td style="text-align: center; padding: 5px;">Approximately 110 minutes</td> <td style="text-align: center; padding: 5px;">Approximately 30 minutes</td> </tr> <tr> <td style="text-align: center; border: 1px solid black; padding: 5px;">SP mode</td> <td style="text-align: center; border: 1px solid black; padding: 5px;">EP mode</td> </tr> </table> <p>Make sure you set this function to “ON” before the timer-recording starts.</p> <p><b>NOTES:</b></p> <ul style="list-style-type: none"> <li>• If you have programmed the VCR to timer-record 2 or more programs, the second program and those thereafter may not fit on the tape with this function set to “ON”. In this case, do not use this function, but change the recording speed manually during timer programming.</li> <li>• In order to ensure that the recording fits on the tape, this function may leave a slight non-recorded portion at the end of the tape.</li> <li>• There may be some noise and sound disturbance where the recording speed switches from SP to EP mode on the tape.</li> <li>• This function is not available during ITR (Instant Timer Recording), and will work properly on the following tapes: T(ST)-30, T(ST)-60, T(ST)-90, and T(ST)-120.</li> </ul>	Approximately 110 minutes	Approximately 30 minutes	SP mode	EP mode
Approximately 110 minutes	Approximately 30 minutes				
SP mode	EP mode				
<p>■ <b>“AUTO TIMER”</b>  “ON”  <b>“OFF”</b></p>	<p><b>When this function is set to “ON”:</b>  The timer recording standby mode is automatically engaged when the VCR is turned off. It is temporarily canceled when the VCR is turned on. You do not have to press [TIMER (⊙)] to engage or disengage the timer recording standby mode.</p> <p><b>When this function is set to “OFF”:</b>  You have to press [TIMER (⊙)] to engage or disengage the timer recording standby mode.</p>				
<p>■ <b>“SUPERIMPOSE”</b>  “ON”  <b>“OFF”</b></p>	<p>When this function is set to “ON”, various VCR status information (on-screen display) appears on the screen.</p> <p><b>NOTES:</b></p> <ul style="list-style-type: none"> <li>• When you use this VCR as the playback VCR for editing a tape, be sure to set this function to “OFF”; otherwise, the VCR status information (on-screen display) will be recorded on the edited tape.</li> <li>• If you select a channel on which no signal is received, the channel number is displayed regardless of this function setting.</li> </ul>				
<p>■ <b>“GRAY BACK”</b>  “ON”  <b>“OFF”</b></p>	<p>When this function is set to “ON”, the VCR changes the screen into the gray back screen automatically when receiving a channel not in use.</p>				

\*The default setting is **bold** in the table below.

<p>■ <b>“POWER SAVE”</b> “ON” “OFF”</p>	<p>When this function is set to “ON”, you can reduce the power consumption. While the VCR is turned off, the front display panel does not show the clock. When this function is set to “ON”, an i.LINK device cannot be recognized. As a result, it is not possible to record a program using the digital tuner’s* timer function. In addition the device does not pass along data if it is in a branched connection.</p> <p><i>*For details of a digital tuner, refer to the instruction manual of the digital tuner.</i></p> <p><b>NOTE:</b> It takes some time until VCR completes its set up when you turn on the VCR.</p>
<p>■ <b>“S-VHS MODE”</b> “ON” “OFF”</p>	<p>You can determine which recording mode - either S-VHS mode or VHS mode - is used for recording on D-VHS and S-VHS tapes. <b>When this function is set to “ON”</b>, you can record on D-VHS and S-VHS tapes with S-VHS picture quality. <b>When this function is set to “OFF”</b>, you can record on D-VHS and S-VHS tapes with VHS picture quality.</p> <p><b>NOTES:</b></p> <ul style="list-style-type: none"> <li>• To record in S-VHS/VHS mode on D-VHS tape, press [D-VHS] to turn off the [D-VHS] indicator.</li> <li>• S-VHS mode allows you to make high quality video recordings with horizontal resolution of 400 lines, comparing with the 230 lines of resolution of conventional VHS recordings. To achieve the highest quality picture we recommend to record in S-VHS mode. (But remember that a conventional VHS VCR without SQPB cannot play back S-VHS tapes recorded in S-VHS mode.)</li> <li>• S-VHS MODE setting does not affect recording on VHS tapes. Recording on VHS tapes is always performed in VHS mode except when using S-VHS ET mode (☞ page 68).</li> </ul>
<p>■ <b>“AV COMPULINK”</b> “ON” “OFF”</p>	<p>The [REMOTE PAUSE/AV COMPULINK] terminal on the rear panel can be used as either the [REMOTE PAUSE] terminal or the [AV COMPULINK] terminal. <b>When this function is set to “ON”</b>, you can use this terminal as the [AV COMPULINK] terminal. By connecting other JVC’s [AV COMPULINK] components (see the diagram below), including amplifiers (or receivers) and televisions, one touch control of the audio and video components linked via their [AV COMPULINK] connectors becomes possible. For example : simply load a cassette in the VCR and press [PLAY (▶)] so that the [AV COMPULINK] components automatically turn on, the TV’s AV mode is selected and the VCR starts playback. (You do not have to press [PLAY (▶)] if the cassette’s record safety tab is removed.) <b>When this function is set to “OFF”</b>, you can use this terminal as the [REMOTE PAUSE] terminal (☞ page 75).</p> <p><b>NOTES:</b></p> <ul style="list-style-type: none"> <li>• When the remote control code is set to C or D, the connector cannot be used as [AV COMPULINK] terminal even if “AV COMPULINK” is set to “ON”. It is recommended to set the remote control code to A when you use this function. (☞ page 78)</li> <li>• Connection varies depending on the type of JVC TV you have. Refer to the TV’s instruction manual when making this connection.</li> </ul>

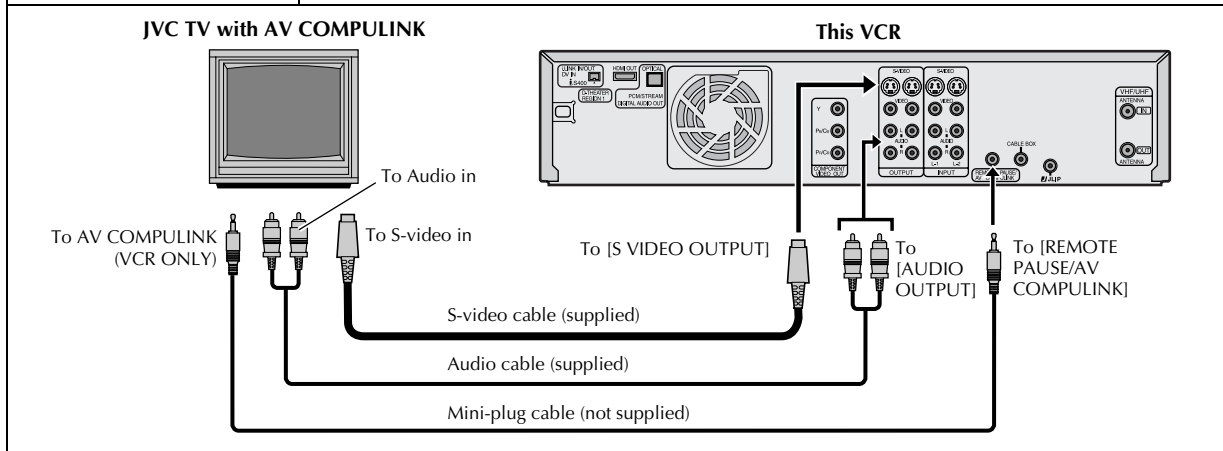

\*The default setting is **bold** in the table below.

<p>■ <b>“S-VHS ET”</b> “ON” “OFF”</p>	<p>This function allows you to record on VHS tapes with S-VHS picture quality. Tapes recorded using this function can be played back on a VCR equipped with the S-VHS ET function. The [S-VHS] indicator on the front display panel lights up when “S-VHS ET” is set to “ON”.</p> <p><b>NOTES:</b></p> <ul style="list-style-type: none"> <li>• Before recording, make sure that “V. CALIBRATION” is set to “ON” (☞ page 63).</li> <li>• You cannot activate the S-VHS ET function... <ul style="list-style-type: none"> <li>- while recording is in progress.</li> <li>- while timer-recording or Instant Timer Recording (☞ page 37) is in progress.</li> <li>- while Video Calibration (☞ page 63) is in progress.</li> </ul> </li> <li>• S-VHS ET does not work with S-VHS tapes.</li> <li>• To keep the highest quality recording and playback pictures over a long period of time, S-VHS recording on S-VHS tapes is recommended.</li> <li>• Use of high grade tapes are recommended for S-VHS ET recordings.</li> <li>• On some tapes, picture quality will not improve even if the S-VHS ET function is used. Check the recording quality before you start important recordings.</li> <li>• You can play back S-VHS ET recordings on most of S-VHS VCRs and of VHS VCR equipped with SQPB (S-VHS QUASI PLAYBACK) function. (Notice some VCRs are not compatible with this function.)</li> <li>• While playing back a tape recorded with this function on some tapes, noise may appear. (If playback picture becomes blurred or interrupted, use a cleaning cassette.)</li> <li>• During special effect playback (☞ page 33), noise may appear. If special effect playback is performed frequently on a tape recorded with this function, the tape may be damaged and picture may be deteriorated.</li> </ul>
<p>■ <b>“DISPLAY”</b> “ON” “OFF”</p>	<p>When this function is set to “OFF”, only [:] appears on the front display panel.</p> <p><b>NOTE:</b></p> <p>Even if you set “DISPLAY” to “OFF”, each item appears on the front display panel in the following cases;</p> <ul style="list-style-type: none"> <li>• when the timer-recording is in progress/in the timer standby mode (☞ page 40 - 50).</li> <li>• in the satellite Auto Recording standby mode (☞ page 47).</li> <li>• during Plug &amp; Play setting (☞ page 16).</li> <li>• when you press [REC (●)] twice for the ITR (☞ page 37).</li> <li>• when you set the remote control code (☞ page 78).</li> <li>• when you press [DISPLAY], the current status appears for a few seconds.</li> </ul>
<p>■ <b>“LIGHTING”</b> “AUTO” “OFF”</p>	<p>This function allows you to turn on/off the blue LED on the front panel.</p>

# JLIP ID Number Setting

- Turn on the VCR and the TV, and select the AV mode on the TV.
- Set the [VCR/TV/CABLE/DBS] selector on the Remote to [VCR].

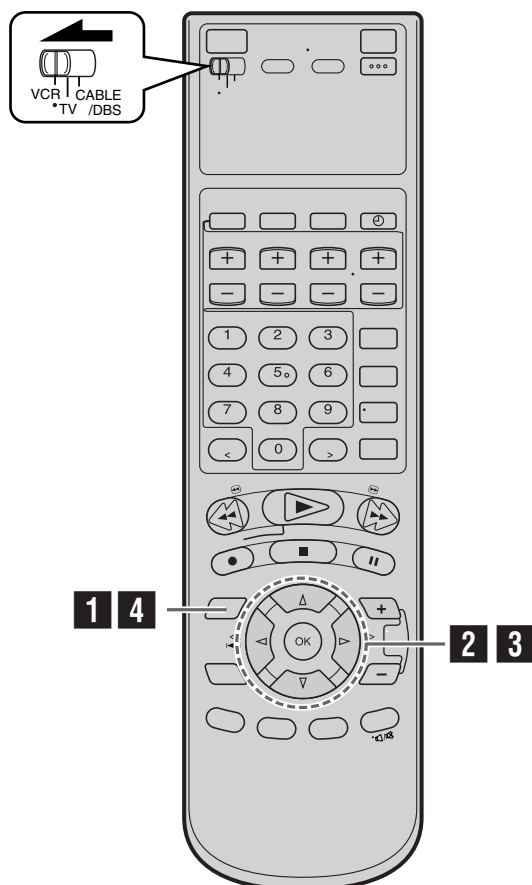

The JLIP (Joint Level Interface Protocol) terminal is used to connect the VCR to a personal computer or similar device. By connecting through the JLIP terminals, you can control the VCR during editing and certain other operations, from the connected personal computer or similar device.

When connecting this VCR to another device using the JLIP terminals, each device must have a different JLIP ID number.

The JLIP ID number of this VCR is preset to "1" when shipped from the factory. You can change this number to any other number between 1 to 99.

**To change the JLIP ID number of this VCR, follow the procedure below.**

## 1 Access Main Menu screen

Press [MENU].

## 2 Select JLIP ID Set Up screen

- 1 Press [◀ ▶] to move the arrow to "INITIAL SET UP", then press [▽] or [OK].
- 2 Press [◀ ▶] to move the arrow to "OTHER", then press [▽] or [OK].

## 3 Set JLIP ID Number

Press [△▽] to move the arrow to "JLIP ID".  
Press [◀ ▶] to enter the desired ID number.

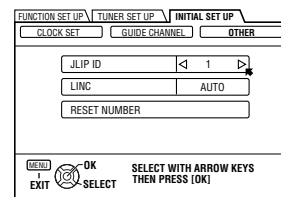

## 4 Return to normal screen

Press [MENU].

### NOTE:

For further details on the JLIP system or devices, consult your nearest JVC dealer.

U.S. customer can contact JVC directly toll free at 1-800-252-5722.

# i.LINK Set Up

- Turn on the VCR and the TV, and select the AV mode on the TV.
- Set the [VCR/TV/CABLE/DBS] selector on the Remote to [VCR].

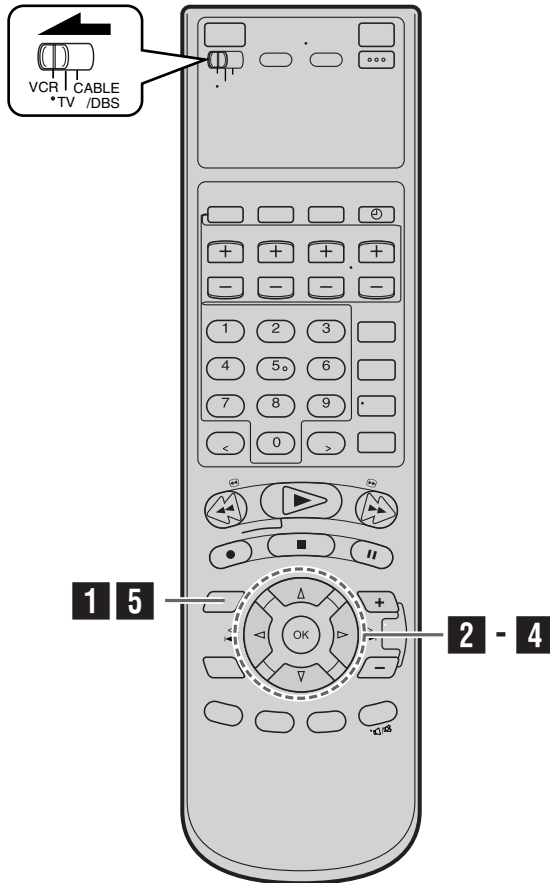

## ATTENTION:

If the i.LINK setting does not work, press [D-VHS] and [STOP (■)] on the front panel simultaneously for more than 5 seconds to reset the settings. The cassette is automatically ejected.

## LINC

You can control one of the i.LINK-compatible devices connected to this VCR with the i.LINK cable. "LINC" means to select one of the connected devices. After establishing a LINC with an i.LINK-compatible device, you're ready to control the i.LINK device. LINC (Logical Interface Connection) involves establishing a logical connection, as the abbreviation implies.

## i.LINK set up for connected device

When you connect i.LINK compatible devices to this VCR, an i.LINK device number is assigned to each device in the order of connection.

If you want to change the number, follow the procedure below.

### 1 Access Main Menu screen

Press [MENU].

### 2 Access i.LINK Set Up screen

- 1 Press [◀ ▶] to move the arrow to "INITIAL SET UP", then press [▽] or [OK].
- 2 Press [◀ ▶] to move the arrow to "OTHER", then press [▽] or [OK].

### 3 Confirm LINC setting

Check that "LINC" is set to "AUTO". If not, press [△▽] to move the arrow to "LINC", then press [◀ ▶] to set to "AUTO".

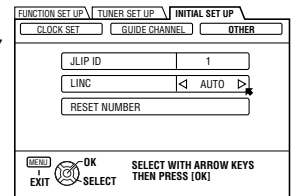

### 4 Reset Number

Press [△▽] to move the arrow to "RESET NUMBER", then press [OK].

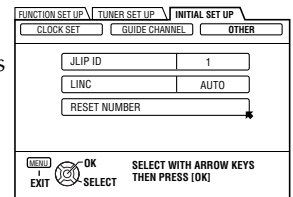

### 5 Return to normal screen

Press [MENU].

### 6 Set Number again

Connect the external devices one by one.

- Make sure to connect the VCR's AC power plug to the AC outlet and turn on the external device before connection.
- Each device will be numbered in the order of connection.

## NOTES:

- If you do not want to set i.LINK device number, set "LINC" to "OFF" in step 3.
- You cannot use the i.LINK connection depending on the type of camcorders equipped with the DV connector. In this case, set "LINC" to "OFF" in step 3.

## What is i.LINK?

i.LINK is a digital serial interface that allows devices equipped with an i.LINK connector to exchange digital video signals, digital audio signals, and device control signals bi-directionally over a single cable.

*i.Link* refers to the IEEE1394-1995 industry specification and extensions thereof. The  logo is used for products compliant with the *i.Link* standard.

This VCR uses a four-pin i.LINK connector to input and output MPEG2 video signals, audio signals, and control signals. The i.LINK connector is also used as an input for DV compressed signals from the DV output of a digital video camera.

## i.LINK Connection

i.LINK-compatible devices can be connected in daisy chain fashion using i.LINK cables.

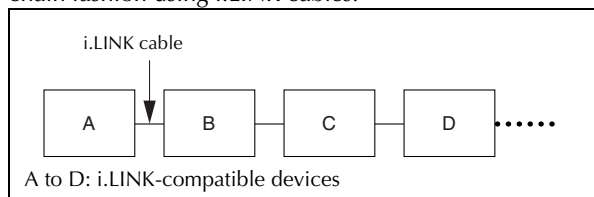

Any two devices in the daisy chain can exchange data bi-directionally, even if there are other devices connected between them.

i.LINK also supports a repeater function that passes input MPEG2 and DV signals through to the next device in the chain.

## i.LINK Branched Connection

If you are connecting a device that is equipped with three or more i.LINK connectors, you can also branch the i.LINK connection.

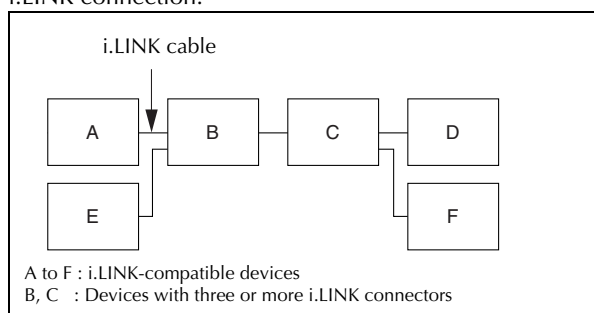

## NOTES:

- You can connect as many as 63 devices (including this VCR) through an i.LINK connection. If you use a branched i.LINK connection, however, the maximum path length on a branch is 17 devices.
- In the case of a personal computer and some other devices, data is not passed along by those devices if the device power is off. For details, refer to the instruction manual for the connected device. Furthermore, data is not passed along by this VCR when "POWER SAVE" is set to "ON" on this VCR (see page 67) and the VCR is turned off.
- The maximum data transfer speed supported by the i.LINK connector on this VCR is 400 Mbps (approximately 400 megabits per second). The maximum data transfer speed that is actually attained may be slower depending on how this VCR is used or if a device with a slower transfer speed is connected to this VCR.
- Use the commercially available i.LINK cable (4-pin, S400, below 3 m). If the cable used is above 3 m, this VCR will not fully maximize its performance.

## i.LINK Connection Examples

Examples of good i.LINK connections and bad i.LINK connections are shown below. The digital signals flow to all connected devices. When connecting i.LINK devices, make sure that the devices are connected in such a way that digital signals do not return (loop back) to the device that output them. Looped connection is not permitted.

### Good connection examples

(A to D: i.LINK-compatible devices)

The connections below do not form a loop

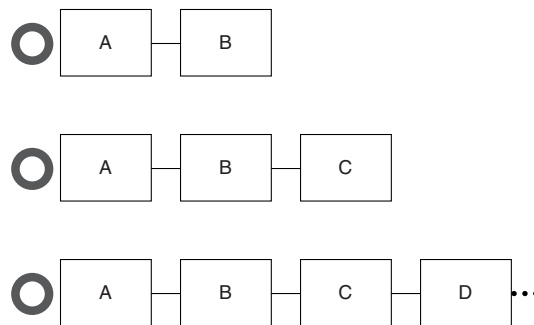

### Bad connection examples

(A to D: i.LINK-compatible devices)

The connections below form a loop.

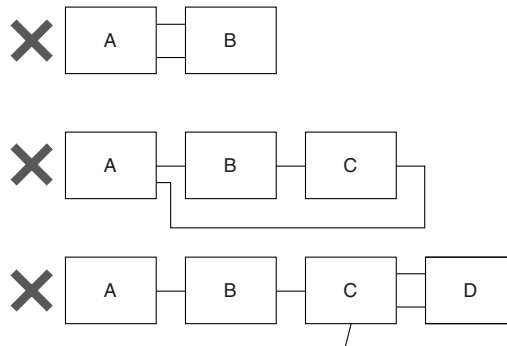

C: Device with three i.LINK connectors

# i.LINK/DV Connections

## NOTES:

- You cannot use the i.LINK connection depending on the type of camcorder equipped with the DV connector. In this case, set "LINC" to "OFF" (☞ page 70).
- If the 44.1 kHz PCM audio signal is input via DV connector, recording cannot be performed properly.
- During DV input, the image format output to the TV will be 480i even if "TV OUTPUT 2" is set to "ALLto480p" (☞ page 65) or "480i to 480p" is set to "ON" (☞ page 65). The status (ON/OFF) of HDMI is also disregarded, however, if the HDMI at the TV supports image format other than 480i, the HDMI output will be muted. The menu settings and the HDMI status will be retained and changes can be made. If you are using a TV with DVI input, and it does not support 480i image format, use the TV's analog input instead.

- A** You can use a camcorder as the playback device and your VCR as the recording VCR.

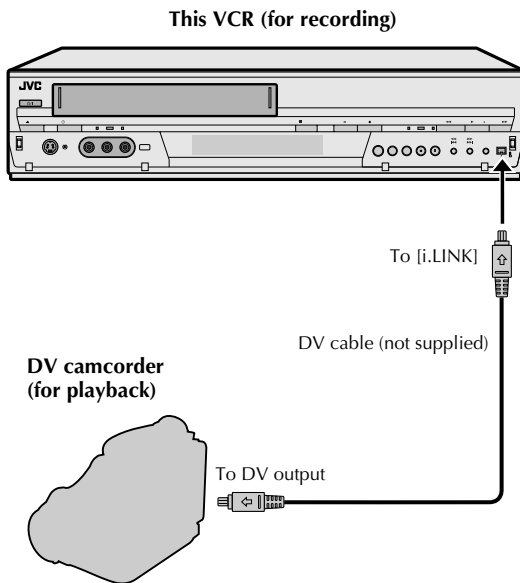

This VCR supports the copy protection technologies of DTLA (Digital Transmission Licensing Administrator). These technologies are admitted by DTLA. It is impossible to dub copy-limited signals between the devices which supports copy protection technologies of DTLA. It is impossible to dub to other tapes the program which only one recording is permitted. When connecting to other devices, only the operation of the devices which supports DTLA is guaranteed. The operation of non-DTLA-supported devices is not guaranteed.

- B** You can use your VCR as the playback or recording VCR.  
E.g. When using this VCR as the recording VCR

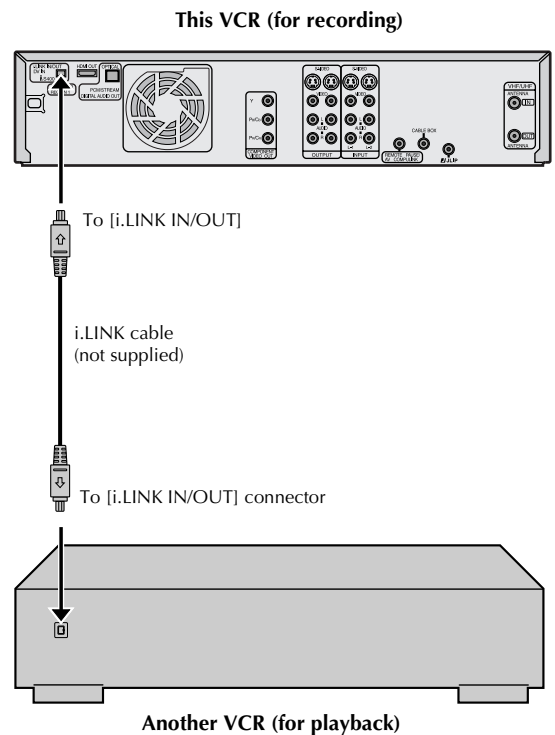



## 1 Make connections

### A Connection with the camcorder

Connect a DV cable between the camcorder's DV connector and your VCR's [i.LINK] connector.

### B Connection with the VCR

Connect an i.LINK cable between the playback VCR's i.LINK input/output connector and the recording VCR's [i.LINK IN/OUT] connector.

### NOTES:

- Depending on the devices equipped with the i.LINK connector which is connected to the VCR, picture noise on this VCR may differ from the noise on the connected devices. It is caused by the difference of the data processing method.
- Connection with certain product(s) may not be supported. (☞ 'ATTENTION' on the back cover.)

## 2 Load a cassette

Insert the cassette to be recorded on into this VCR (for recording).

## 3 Select input location on this VCR

### On the front panel:

Press [CHANNEL +/-] to select "I-1" etc.

### On the Remote:

Press [TV/VCR CH +/-] to select "I-1" etc.

- When "I-1" is selected, either the front or the rear i.LINK connector can be used, the VCR will automatically switch to the appropriate connector being used.

## 4 Set recording speed

Press [REC SPEED] to set the recording speed.

- For more details, refer to 'About Recording Speed' below.

## 5 Start playback

Press [PLAY ▶] on the connected device.

### NOTE:

If the connected device is equipped with a superimpose/OSD disable feature then set it to "OFF" before starting playback.

## 6 Start recording

### On the front panel:

Press [REC ●].

### On the Remote:

Press [REC ●] and [PLAY ▶] at the same time.

### NOTE:

If "108 REC BY HS MODE" appears on the TV screen, refer to 'Error Codes and Messages' on page 84.

**Do not connect this VCR to the PC with the i.LINK cable. The operation is not guaranteed.**

### About Recording Speed

	Input Source (Playback device)	Selectable Recording Speed (Recording device: This VCR)
i.LINK/ DV input	D-VHS	Auto (HS/STD)*, HS, STD, LS3
	DV-camcorder	HS, STD, LS3
	Digital Set Top Box (Others)	Auto (HS/STD)*, HS

\*Auto mode : The recording speed will be selected automatically according to the amount of data input (the transfer rate) from the i.LINK connector.

### NOTES:

- When dubbing using the i.LINK connector, set the recording speed on the recording VCR to the same speed as the source tape on the playback VCR.
- When Auto is selected for the recording speed, "AUT" and the selected speed appear on the front display panel in turn.

# S-VIDEO/VIDEO Connections

## Various connection for editing tapes

The following three methods can be used for editing tapes.

- **VHS to S-VHS editing (VIDEO-VIDEO connection):**  
Although the picture quality is inherently limited by the original VHS quality, the edited tape has better picture quality than those made by VHS-to-VHS editing.
- **S-VHS to VHS editing (VIDEO-VIDEO connection):**  
Since the original source is recorded in S-VHS mode, the edited tape has better picture quality than those made by VHS-to-VHS editing.
- **S-VHS to S-VHS editing (S-VIDEO connection):**  
Original picture quality of S-VHS made can be duplicated with minimal picture degradation. This is the best editing method you can use on S-VHS VCRs.

- A** You can use a camcorder as the playback device and your VCR as the recording VCR.

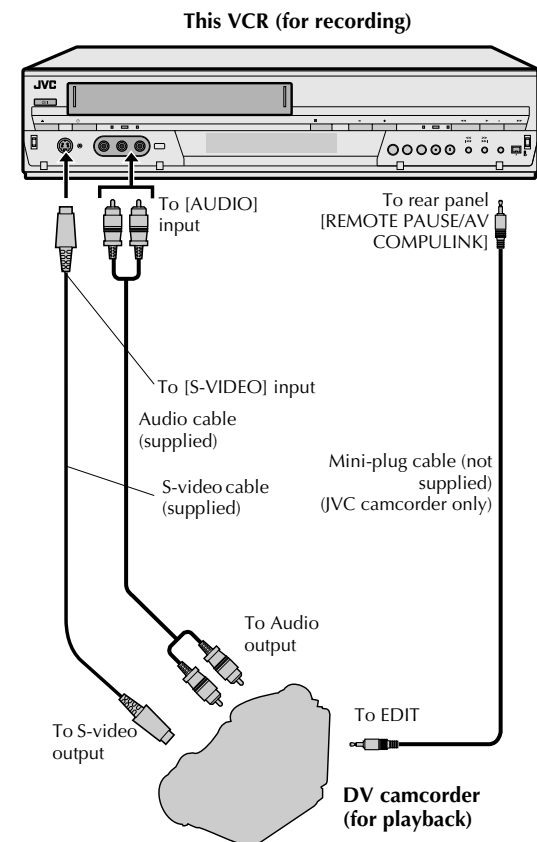

- B** You can use your VCR as the playback or recording VCR.  
E.g. When using this VCR as the recording VCR

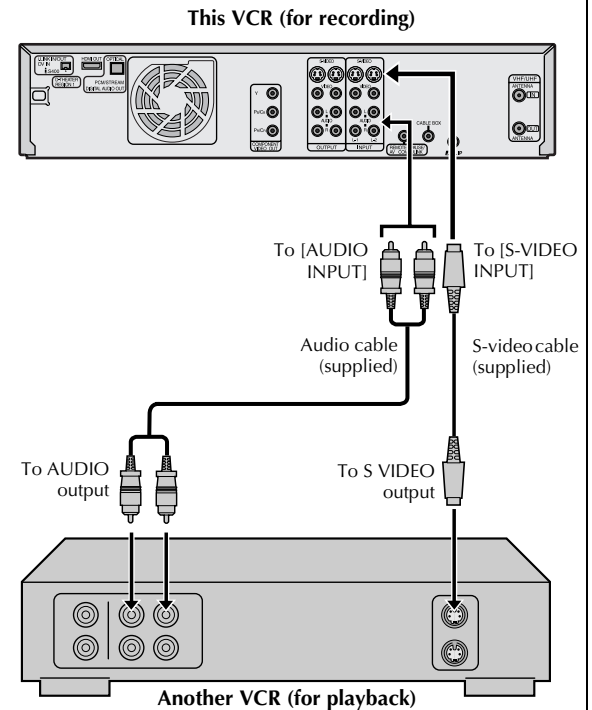

## NOTE:

**When using this VCR as the playback VCR,**

During playback, if the images cannot be displayed on the TV, press [HDMI] on the front panel to turn off the [HDMI] LED and set "TV OUTPUT 2" to "ALLto480i" (see page 65). In event when even the main menu screen cannot be displayed on the TV when [MENU] is pressed, power off this VCR, press and hold [PAUSE (II)] for more than 5 seconds, then power on the VCR again.

## 1 Make connections

### A Connection with the camcorder

Connect an audio/S-video cable between the camcorder's audio/S-video output connectors and your VCR's [AUDIO/S VIDEO] input connectors.

- When the JVC camcorder is equipped with the Master Edit Control, you can control the VCR from the camcorder. Connect the mini-plug cable (not supplied with this VCR) as illustrated on the left.
- When using a camcorder with a monaural output, connect the audio output connector on the camcorder to the [AUDIO L] input connector on this VCR.

## NOTE:

If the camcorder does not have S-video output connector, use a video cable.

**B Connection with the VCR**

Connect an audio/S-video cable between the playback VCR's audio/S-video output connectors and the recording VCR's [AUDIO/S VIDEO INPUT] connectors.

- When using this VCR as the recording VCR, connect this VCR's [AUDIO/S VIDEO INPUT] connectors to the audio/S-video output connectors on the other VCR. If the playback VCR is monaural, connect the audio output connector on the playback VCR to the [AUDIO L INPUT] connector on this VCR.

**NOTE:**

If another VCR does not have S-video input/output connectors, use a video cable.

**2 Load a cassette**

Insert the cassette to be recorded on into this VCR (for recording).

**3 Select input location on this VCR**

- [L-1] or [L-2] — when connecting the device to the [AUDIO/VIDEO INPUT] or [AUDIO/S VIDEO INPUT] connectors on the rear panel.
- [F-1] — when connecting the device to the [AUDIO/VIDEO] or [AUDIO/S VIDEO] input connectors on the front panel.

**On the front panel:**

Press [CHANNEL +/-].

**On the Remote:**

Press the 'Number' key [0 (AUX)] or [TV/VCR CH +/-].

**NOTE:**

When using this VCR as the recording VCR, set the video input terminal setting correctly. This setting selects either the S-Video or composite video (page 65).

**4 Set recording speed**

Press [REC SPEED] to set the tape speed.

Input Source (Playback device)		Selectable Recording Speed (Recording device: This VCR)
Analog input	D-VHS	HS, STD, LS3
	S-VHS/VHS	SP, EP

**5 Select video input terminal**

Access the "IN/OUT FUNCTION" screen (page 65).

**When using [S VIDEO] terminal,** set "FRONT AUX F-1" (or "REAR AUX L-1" (or "L-2")) if you use the connectors on the rear) to "S-VIDEO".

**When using [VIDEO] terminal,** set "FRONT AUX F-1" (or "REAR AUX L-1" (or "L-2")) if you use the connectors on the rear) to "VIDEO".

**6 Set "PICTURE CONTROL" to "EDIT"**

Access the "VIDEO FUNCTION" screen (page 63).

**7 Start playback**

Press [PLAY (▶)] on the connected device.

**NOTE:**

If the connected device is equipped with a superimpose/OSD disable feature then set it to "OFF" before starting playback.

**8 Start recording****On the front panel:**

Press [REC (●)].

**On the Remote:**

Press [REC (●)] and [PLAY (▶)] at the same time.

**To use a Master Edit Control-equipped JVC camcorder**

**1** Access the "ADDITIONAL" screen (page 66), then set "AV COMPU-LINK" to "OFF" after performing step **6**.

- The REMOTE PAUSE/AV COMPULINK connector works as a Remote Pause connector when "AV COMPU-LINK" is set to "OFF".
- For details, refer to the camcorder's instruction manual.

**2** Engage the VCR's recording pause mode.

**NOTES:**

- Be sure to select "AUTO" for "PICTURE CONTROL" (or "NORM" when "V. CALIBRATION" is set to "OFF") after you finish dubbing the tapes (page 63).
- It is impossible to perform dubbing properly only with an audio cable. Connect also the video or S-video cable.

# TV Brand Setting

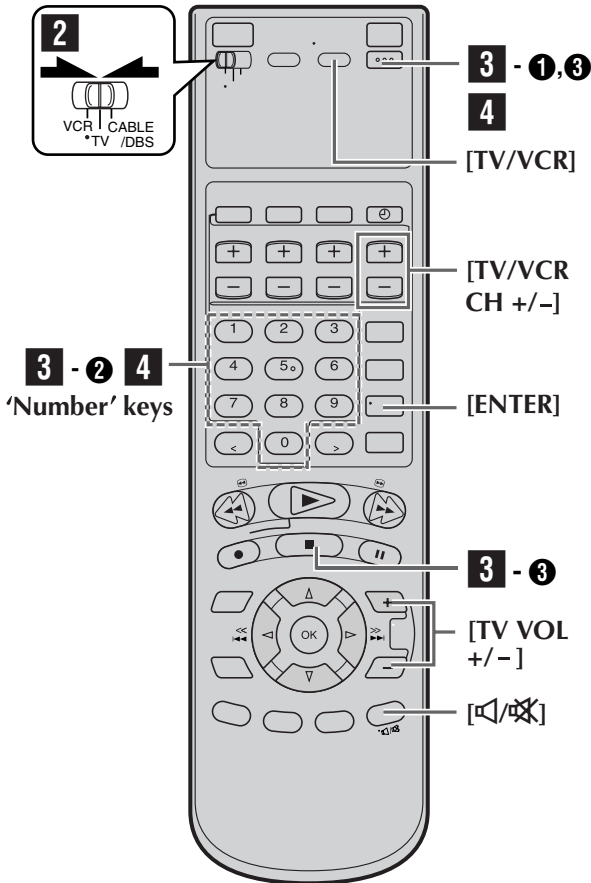

## 1 Turn on the TV

Turn on the TV using the Power button on the TV or its Remote.

## 2 Set remote operation mode

Set the [VCR/TV/CABLE/DBS] selector to [TV].

## 3 Set TV brand code

Follow the example shown below.

- 1 Press and hold [POWER].
- 2 Press the 'Number' keys to enter your TV's brand code by referring to the table below.
- 3 Press [STOP (■)], and release [POWER].

- Once you have set the Remote to operate the TV, you do not have to set it until you replace the batteries from the Remote.
- JVC and PANASONIC have two codes. If the TV does not function with one code, try entering the other.

## 4 Operate TV

Press one of the following buttons:

[POWER], [TV/VCR], [TV/VCR CH +/-], [MUTE] (TV Muting), [TV VOL +/-], and 'Number' keys.

- For some brands, you must press [ENTER] after having pressed the 'Number' keys to enter a channel number.
- To operate the VCR, set the [VCR/TV/CABLE/DBS] selector back to [VCR].

TV BRAND NAME	BRAND CODE
JVC	01, 03
HITACHI	10
MAGNAVOX	02
MITSUBISHI	03
PANASONIC	04, 11
RCA	05
SHARP	06
SONY	07
SAMSUNG	12
SANYO	13
SEARS	13
TOSHIBA	08
ZENITH	09

### NOTES:

- Depending on the type of TV, some or all functions cannot be operated using this Remote.
- It's not possible to operate a TV not equipped with a remote sensor.

(E.g.) To set Remote to RCA 05:

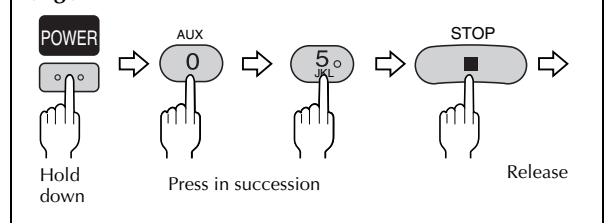

# Cable Box or DBS Receiver Brand Setting

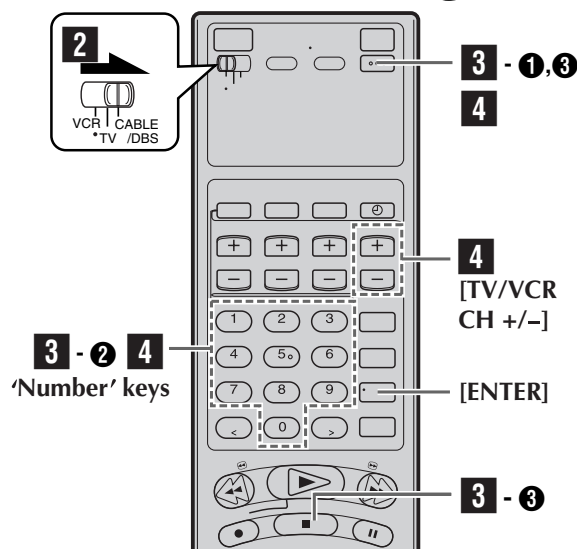

When programmed (set) with a manufacturer's (brand's) code, this Remote can perform some of the remote control functions of the listed cable boxes or DBS (Direct Broadcast Satellite) receivers.

If your cable box does not function with a specified code, try other codes.

## 1 Turn on the cable box or DBS receiver

Turn on the cable box (or DBS receiver) using the Power button on the cable box (or DBS receiver) or its Remote.

## 2 Set remote operation mode

Set the [VCR/TV/CABLE/DBS] selector to [CABLE/DBS].

## 3 Enter brand code

Follow the example shown below.

- 1 Press and hold [POWER].
- 2 Press the 'Number' keys to enter your cable box's (or DBS receiver's) brand code by referring to the table below.
- 3 Press [STOP (■)], and release [POWER].

• Once you have set the Remote to operate a cable box (or DBS receiver), you do not have to set it again until you replace the Remote's batteries.

## 4 Operate cable box or DBS receiver

Press one of the following buttons: [POWER], [TV/VCR CH +/-], and 'Number' keys.

- For some brands, you must press [ENTER] after having pressed the 'Number' keys to enter a channel number.
- To change the cable box's (or DBS receiver's) channels, press [TV/VCR CH +/-] or the 'Number' keys.
- To operate the VCR, set the [VCR/TV/CABLE/DBS] selector back to [VCR].

### NOTES:

- Depending on the type of cable box (or DBS receiver), some or all functions cannot be operated using this Remote.
- It is impossible to control a cable box (or DBS receiver) that does not have a remote sensor.
- It's not possible to set the Remote for both your cable box and a DBS receiver at the same time. You can only set the Remote to operate one of these units at a time.

CABLE BOX BRAND NAME	BRAND CODE
ARCHER	01, 05, 17
CABLETENNA	01, 17
CABLEVIEW	15, 16, 17, 21, 25
CITIZEN	15, 16, 17, 21, 25
CURTIS	02
DIAMOND	01, 17
GC BRAND	15, 16, 17, 21, 25
GEMINI	15
GENERAL INSTRUMENTS	01, 04, 06, 11, 12, 15, 28
HAMLIN	10, 18, 23
JASCO	15
JERROLD	01, 04, 06, 11, 12, 15, 28
NOVAVISION	02
OAK	07
PANASONIC	13, 14
PULSER	15, 16, 17, 21, 25
RCA	13, 14
REGAL	10, 18, 23
REMBRANDT	01, 16, 17
SAMSUNG	05, 16, 24
SCIENTIFIC ATLANTA	02
SIGMA	07
SL MARX	05, 16, 17, 24, 25
SPRUCER	13, 14
STARGATE	05, 15, 16, 17, 21, 24, 25
TELEVIEW	05, 16, 24
TOCOM	01, 04, 16
UNIKA	01, 17
UNIVERSAL	16, 17, 25
VIDEOWAY	03, 09, 22
ZENITH	03, 09, 22

DBS BRAND NAME	BRAND CODE
JVC (DISH Network)	51
ECHOSTAR (DISH Network)	51
SONY (DSS)	41
RCA (DSS)	40

(E.g.) To set the Remote for the cable box to RCA 14:

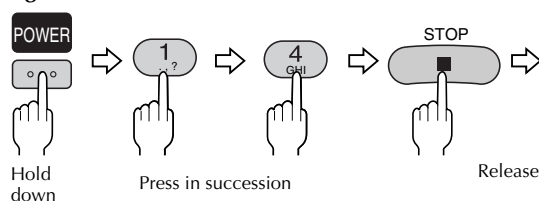

# Changing Remote Control Code

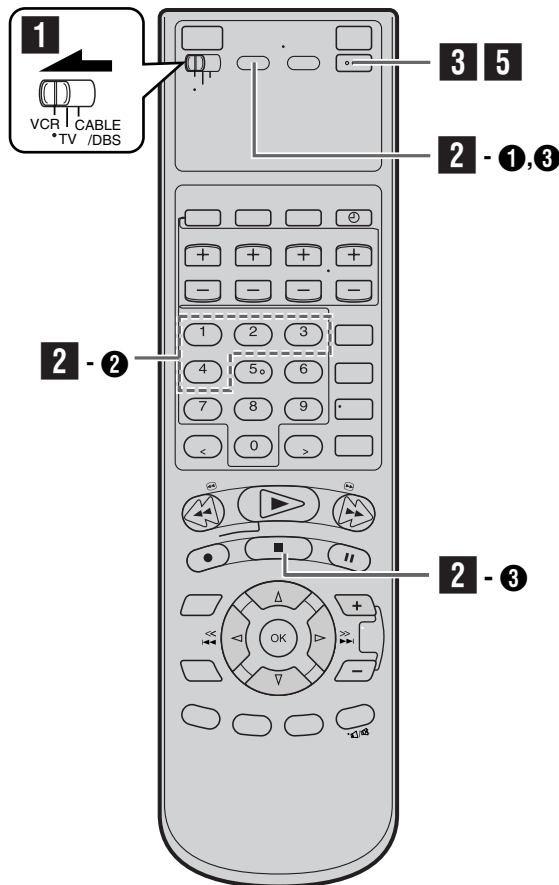

The Remote is capable of controlling four JVC video recorders independently. Each of VCRs can respond to one of four codes (A, B, C or D).

This Remote control is preset to send A code signals because your VCR is initially set to respond to A code signals. You can easily change your Remote and the VCR to send and respond to B, C or D code signals.

When using four JVC VCRs, set the four VCRs and their Remotes to different codes, so that the Remotes can operate these VCRs separately.

## 1 Set remote operation mode

Set the [VCR/TV/CABLE/DBS] selector to [VCR].

## 2 Set remote control code for Remote

- 1 Press and hold [A/B/C/D].
- 2 Press the 'Number' key [1] for A code control signals, [2] for B code control signals, [3] for C code control signals and [4] for D code control signals.
- 3 Press [STOP (■)], and release [A/B/C/D].

## 3 Turn off VCR

Press [POWER] on the VCR.

## 4 Check remote control code for VCR

Press [PLAY (▶)] on the VCR for more than 5 seconds.

- The code currently set appears on the front display panel.

## 5 Turn on VCR

Press [POWER] on the Remote.

- The code transmitted from the Remote blinks for a few seconds on the front display panel.
- After the code disappears on the front display panel, make sure that the VCR is turned on by pressing [POWER] on the Remote.

### To control four VCRs with the same Remote

You can control four JVC VCRs by switching the remote control code for the Remote between A, B, C and D as in step 2, keeping four VCRs to different control codes.

- Press the 'Number' key [1] for A code control signals, [2] for B code control signals, [3] for C code control signals and [4] for D code control signals. (To change only the remote control code for the Remote, DO NOT perform steps 3 to 5.)

### NOTE:

When "POWER SAVE" is set to "ON", you can not change the remote control code. Before changing the code, set "POWER SAVE" to "OFF" (page 67).

### (E.g.) To set Remote to B code:

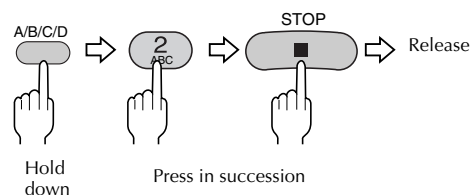

Before requesting service, use this chart and see if you can repair the trouble yourself. Small problems are often easily corrected, and this can save you the trouble of sending your VCR off for repair.

**POWER**

SYMPTOM	POSSIBLE CAUSE	CORRECTIVE ACTION
1. The power will not come on.	• The AC power cord is disconnected.	Connect the AC power cord.
2. The clock works, but the VCR's power will not come on.	• The VCR is in the timer recording standby mode with "AUTO TIMER" set to "OFF" (☞ page 66).	Press [TIMER (Ⓞ)] to disengage.
3. The Remote will not function.	• The batteries are weak.	Replace the dead batteries with new ones.

**TAPE TRANSPORT**

SYMPTOM	POSSIBLE CAUSE	CORRECTIVE ACTION
1. The cassette gets stuck partway during loading, and is ejected.	• The cassette was inserted incorrectly.	Make sure the cassette's window is facing up, the rear label side is facing you and the arrow on the front of the cassette is pointing towards the VCR. Then insert the cassette.

**PLAYBACK**

SYMPTOM	POSSIBLE CAUSE	CORRECTIVE ACTION
1. The tape is running but the picture will not appear.	• The TV receiver is set to the wrong mode.	If you are using the AV, HDMI, DVI, Component Video or S-Video connection, set the TV to its AV mode.
2. Breaks are noticeable in Hi-Fi sound track.	• Automatic tracking is engaged.	Disengage auto tracking and adjust the tracking manually (☞ page 30).
3. The playback picture is blurred or interrupted, even though TV broadcasts are clear.	• The video heads may be dirty.	The heads must be cleaned. Use an optional dry cleaning cassette, or consult your JVC dealer.
4. The picture stops, or the black or mosaic noise appears when playing back a program recorded in D-VHS mode.	• The video heads may be dirty. • The digital program is not recorded in D-VHS mode.	The heads must be cleaned. Use an optional dry cleaning cassette, or consult your JVC dealer. To record in the D-VHS mode, use a D-VHS cassette.
5. The Hi-Fi sound cannot be heard.	• Audio Monitor setting is incorrect.	Set Audio Monitor to "▷ L R ◁" (☞ page 30).
6. The [D-VHS] indicator does not light up when playing back a D-VHS cassette.	• The program is not recorded in D-VHS mode.	To record the program in D-VHS mode, press [D-VHS] so that the [D-VHS] indicator lights up, then perform the recording (☞ page 35).
7. The mosaic noise appears when receiving the scenes with fast action or switching the display.	• This occurs when receiving the program with the low transfer rate.	This noise already appears in the broadcast station, and this is not a malfunction of your VCR.
8. Images cannot be displayed on the TV. And the [ ] indicator on the front display panel lights up.	• Your TV supports only 480i image format, but "TV OUTPUT 2" has been previously set to "ALLto480p" (☞ page 65).	Press [HDMI] on the front panel to turn off the [HDMI] LED, and set "TV OUTPUT 2" to "ALLto480i" (☞ page 65). When the main menu screen does not appear even when [MENU] is pressed, power off this VCR, press and hold [PAUSE (⏸)] on the front panel for more than 5 seconds, then power on the VCR again.

## PLAYBACK

SYMPTOM	POSSIBLE CAUSE	CORRECTIVE ACTION
9. Sound cannot be heard.	<ul style="list-style-type: none"> <li>When a HDMI to DVI conversion cable is connected between the VCR and TV, you need to connect the audio cable as well to receive sound output.</li> <li>A HDMI to HDMI connection has been made, but the HDMI digital sound function at the TV side may support only 2ch-PCM.</li> <li>Your TV is unable to decode Dolby Digital or DTS bitstream, thus there is no sound output.</li> </ul>	<p>Connect an audio cable between the VCR and TV.</p> <p>Make use of the analog audio input connector coupled with the HDMI video input at the TV side to connect to the VCR's audio output.</p> <p>Make use of the analog audio input connector coupled with the HDMI video input at the TV side to connect to the VCR's audio output.</p>

## RECORDING

SYMPTOM	POSSIBLE CAUSE	CORRECTIVE ACTION
1. Recording will not start.	<ul style="list-style-type: none"> <li>There is no cassette loaded.</li> <li>The loaded cassette has had its record safety tab removed.</li> </ul>	<p>Insert a cassette.</p> <p>Remove the cassette and cover the hole with adhesive tape, or load a cassette on which the record safety tab is intact.</p>
2. TV broadcasts will not be recorded properly.	<ul style="list-style-type: none"> <li>The VCR has been set to "L-1", "L-2", "F-1" or "I-1" etc. input location by mistake.</li> </ul>	<p>Select the appropriate channel on the VCR.</p>
3. Tape-to-tape editing will not work.	<ul style="list-style-type: none"> <li>The components have been incorrectly connected, or correct video connector ([S VIDEO], [VIDEO] or DV) is not selected.</li> <li>The power to one or more of the units has not been turned on.</li> <li>The recording VCR's input location has been set incorrectly.</li> </ul>	<p>Connect the components correctly (pages 72, 74) or check "REAR AUX L-1" (or "L-2") and "FRONT AUX F-1" setting (page 65).</p> <p>Make sure the power to all units is on.</p> <p>Select the appropriate input location on the recording VCR.</p>

## TIMER RECORDING

SYMPTOM	POSSIBLE CAUSE	CORRECTIVE ACTION
1. Timer recording will not work.	<ul style="list-style-type: none"> <li>The clock and/or the timer have been set incorrectly.</li> <li>The timer is not engaged.</li> <li>The VCR has not been set up properly.</li> </ul>	<p>Set the clock and/or timer correctly.</p> <p>Press [TIMER (Ⓞ)] and check to make sure that [Ⓞ] appears on the front display panel.</p> <p>Re-perform the set-up procedures. Make sure you have compensated for guide channel and VCR or cable box channel number mismatches (page 42).</p>
2. Timer recording for D-VHS via i.LINK connection will not work.	<ul style="list-style-type: none"> <li>There is no linkage between the VCR and the HDTV (or Digital Set Top Box).</li> <li>Timer programming on the HDTV (or Digital Set Top Box) has not been set correctly.</li> </ul>	<p>Set up link between the VCR and the HDTV (or Digital Set Top Box).</p> <p>Check the timer program data on the HDTV (or Digital Set Top Box) and set again if necessary.</p>
3. Timer programming will not work.	<ul style="list-style-type: none"> <li>Timer recording is in progress.</li> </ul>	<p>Timer programming cannot be performed when timer recording is in progress. Wait until it finishes.</p>



## TIMER RECORDING

SYMPTOM	POSSIBLE CAUSE	CORRECTIVE ACTION
4. [⊙] blinks on the front display panel.	<ul style="list-style-type: none"> <li>The timer is engaged but there is no cassette loaded.</li> <li>[TIMER (⊙)] has been pressed when there are no programs in memory, or the timer recording program has not been set correctly.</li> </ul>	Load a cassette with the record safety tab intact, or with the hole covered with adhesive tape. Check the programmed data and set again if necessary, then press [TIMER (⊙)] again.
5. [⊙], [○] and [▷] on the front display panel will not stop blinking when the timer is engaged.	<ul style="list-style-type: none"> <li>The loaded cassette has had its record safety tab removed.</li> </ul>	Remove the cassette and cover its hole with adhesive tape, or replace it with a cassette on which the safety tab is intact.
6. The cassette stops automatically, and [⊙], [○] and [▷] on the front display panel will not stop blinking.	<ul style="list-style-type: none"> <li>The tape reaches its end during timer recording.</li> </ul>	The program may not have been recorded in its entirety. Next time be sure you have enough time on the tape to record the entire broadcast.
7. Cable channels are not automatically switched during timer recording.	<ul style="list-style-type: none"> <li>The Controller is not properly connected to the VCR.</li> <li>The input channel selected on the Cable Set Up screen is incorrect.</li> <li>The cable box is turned off.</li> </ul>	Connect the Controller correctly (☞ page 22). After confirming your cable box's input channel number, re-access the Cable Set Up screen and select the correct number (☞ page 23). Make sure the power is on before timer recording starts.
8. Satellite channels are not automatically switched during timer recording.	<ul style="list-style-type: none"> <li>The Controller is not properly connected to the VCR.</li> <li>The input channel selected on the DBS Receiver Set screen is incorrect.</li> <li>The VCR is not set correctly to control the DBS receiver.</li> <li>The DBS receiver is turned off.</li> </ul>	Connect the Controller correctly (☞ page 25). After confirming your DBS receiver's input channel number, re-access the DBS Receiver Set screen and select the correct number (☞ page 26). Set the correct DBS receiver brand code (☞ page 27). Make sure the power is on before timer recording starts.
9. Timer recording begins as scheduled, but the channel is always incorrect.	<ul style="list-style-type: none"> <li>Even though you do not use an external cable box or DBS receiver, on the Cable Set Up screen or DBS Receiver Set screen, "INPUT CH" is set to "ON".</li> </ul>	Set "INPUT CH" to "OFF" (☞ pages 23, 26).
10. You moved, and now VCR Plus+ system does not work properly.	<ul style="list-style-type: none"> <li>The receivable stations in the new area are received on different channels than those in the previous area.</li> </ul>	Re-perform the Changing VCR Plus+ Setting procedure (☞ page 42).
11. "PROGRAM FULL" is displayed on the screen.	<ul style="list-style-type: none"> <li>All 24 programs of the VCR's timer memory are used.</li> </ul>	Wait until a space in memory clears, or cancel unnecessary program information (☞ page 46).

## VIDEO NAVIGATION

SYMPTOM	POSSIBLE CAUSE	CORRECTIVE ACTION
1. Tape information screen does not appear for the currently inserted tape.	<ul style="list-style-type: none"> <li>The current tape inserted has not been recorded on this VCR.</li> </ul>	Tape information cannot be shown if it has not been recorded on this VCR.

## VIDEO NAVIGATION

SYMPTOM	POSSIBLE CAUSE	CORRECTIVE ACTION
2. The VCR cannot search for the desired program.	<ul style="list-style-type: none"> <li>• Two (or more) tape numbers are recorded on one tape.</li> <li>• The inserted program is not recorded on this VCR.</li> </ul>	Video Navigation cannot work correctly on a tape if it has more than one tape number. If this happens, fast-forward the tape up to its end, eject it, and try it again. It is impossible to search the desired program which is not recorded on this VCR using Video Navigation.
3. "MEMORY FULL" appears on the screen when you try to start recording.	<ul style="list-style-type: none"> <li>• The VCR's memory for Video Navigation is fully recorded.</li> </ul>	Check the remaining memory (☞ page 61). If it is full, delete unnecessary Video Navigation information (☞ pages 60, 61).
4. The information data for Video Navigation is not registered.	<ul style="list-style-type: none"> <li>• The VCR's memory for Video Navigation is fully recorded.</li> <li>• "NAVIGATION" is set to "OFF".</li> <li>• The recording time is not enough.</li> </ul>	Check the remaining memory (☞ page 61). If it is full, delete unnecessary Video Navigation information (☞ pages 60, 61). Set "NAVIGATION" to "ON" (☞ page 52). For details on the recording time for Video Navigation, refer to 'NOTES' on page 51.

## OTHER PROBLEMS

SYMPTOM	POSSIBLE CAUSE	CORRECTIVE ACTION
1. When scanning channels, some of them are skipped over.	<ul style="list-style-type: none"> <li>• Those channels have been preset to be skipped.</li> </ul>	If you need the skipped channels, restore them (☞ page 21).
2. The channel cannot be changed.	<ul style="list-style-type: none"> <li>• Recording is in progress.</li> </ul>	Press [PAUSE (III)] to pause the recording, change channels, then press [PLAY (▶)] to resume recording.
3. The Remote will not operate your TV or cable box or DBS receiver.	<ul style="list-style-type: none"> <li>• The brand codes are set incorrectly.</li> </ul>	Reset the correct brand codes (☞ pages 76, 77).
4. Even though Auto or Semiauto Clock Set has been performed, the clock is incorrect.	<ul style="list-style-type: none"> <li>• The clock setting data received from the host channel is incorrect.</li> </ul>	Select a different host channel during Semiauto Clock Set (☞ page 18), or perform Manual Clock Set (☞ page 19).
5. "PM" blinks on the front display panel.	<ul style="list-style-type: none"> <li>• The VCR do not work properly.</li> </ul>	Unplug the AC power plug once, then plug it again.
6. The subtitles and the menu screen are overlapped.	<ul style="list-style-type: none"> <li>• The subtitle display on the TV is set to on.</li> </ul>	Set it to off.
7. The subtitles cannot be displayed.	<ul style="list-style-type: none"> <li>• You are viewing the program in EE mode through the HDMI connection.</li> </ul>	Make use of the analog connection (Component Video, S-Video or Video), and set "TV OUTPUT 2" to "ALLto480i" (☞ page 65). However, if the picture is of 480p image format, the subtitles cannot be displayed.

The following conditions are product features and do not indicate mechanical problems.

#### **Playback of tapes recorded in D-VHS mode**

- You may see a mosaic (block) noise, grayed images, or a still image in cases of excessive distortion caused when playing back a damaged tape or when the heads are momentarily dirty.
- After you press [PLAY (▶)], it takes a moment until you see the image and hear the sound.
- After you switch playback speeds (when switching from special effect playback to normal playback, for example), it takes a moment until you see the image and hear the sound. For a few seconds, the image may be played back out of sync with the sound.

#### **Searching images on D-VHS tapes**

- The images appear frame by frame.
- Block noise may appear on the bottom half of images.
- When the blank portion is reached, a still scene of the last recorded image is displayed.

#### **The picture stops/There is no sound**

- When two or more devices are connected to this VCR with the i.LINK cable (a camcorder and another i.LINK-compatible device), do not turn on the camcorder if you record a program from an another i.Link-compatible device. Turning on and off the camcorder may cause momentary still images and loss of sound.

#### **Image or sound is distorted**

- When recording from a camcorder connected to this VCR with the i.LINK cable, the image or sound may be distorted. If this occurs, insert a D-VHS cassette in the VCR and turn off and on the VCR, then start recording again. If the problem is not fixed, record using the audio/video input connectors instead of i.LINK connector.

#### **MOISTURE CONDENSATION**

Moisture in the air will condense on the VCR when you move it from a cold place to a warm place, or under extremely humid conditions—just as water droplets form on the surface of a glass filled with cold liquid. Moisture condensation on the head drum will cause damage to the tape. In conditions where condensation may occur, keep the VCR turned on for a few hours to evaporate the moisture before inserting a tape.

#### **ABOUT HEAD CLEANING**

Accumulation of dirt and other particles on the video heads may cause the playback picture to become blurred or interrupted. Be sure to contact your nearest JVC dealer if such troubles occur.

#### **Recording from camcorders and other devices via i.LINK connector**

- You may see a mosaic (block) noise.
- For scenes with fast action, the image may jitter. This does not affect recording, which will proceed as usual.
- When you watch the camcorder's search images through this VCR, the block noise may appear.
- When you record audio-dubbed DVC cassettes (tapes which have four recorded channels), sound may not be heard for the first few seconds.
- When you eject and insert D-VHS cassettes, the sound may be interrupted for an instant.
- When you press [REC SPEED] to switch recording speed, the sound may be interrupted for an instant.

#### **Incorrect image formatting for wide TVs**

- If you have connected two different devices using the S-video output connectors on the back of the VCR, the sensing signal for wide TVs may not be output correctly depending on the connected devices. If this occurs, use the TV controls to switch the screen size.

#### **ATTENTION**

This VCR contains microcomputers. External electronic noise or interference can cause microcomputer to malfunction. If the VCR does not operate correctly switch its power off and unplug the AC power cord from the AC supply. Wait for a while and then plug the power back in. Eject and check the condition of the cassette. If everything appears normal, you can operate the VCR as usual.

## Error Codes and Messages

Some error codes and messages may appear on the TV screen when operating the VCR. Refer to the chart below for the solution.

CODE	MESSAGE	DESCRIPTION
102	"REC PROHIBITED"	<ul style="list-style-type: none"> <li>• An attempt was made to make a D-VHS recording of a program for which only the analog information is copy protected.</li> <li>• While making a D-VHS recording of a program, a signal in which only the analog information is copy protected was input to this VCR.</li> </ul>
103	"REC PROHIBITED"	<ul style="list-style-type: none"> <li>• An attempt was made to dub a D-VHS recording of a digitally copy protected program.</li> <li>• While dubbing a D-VHS recording, digitally copy protected information was input to this VCR.</li> <li>• This VCR supports copy protection technologies such as DTLA, and cannot record programs that employ digital copy protection.</li> </ul>
104	"CAN NOT DECODE VIDEO OR AUDIO USE SET TOP BOX OR HDTV TUNER"	<ul style="list-style-type: none"> <li>• A signal that is not compatible with this VCR was input.</li> <li>• Switch to the analog input for recording. (It may be possible to play back the material if using a digital tuner*, etc.)</li> </ul>
105	"CAN NOT REC DIGITAL INPUT BY S- VHS/VHS" "CHOOSE ANALOG INPUT"	<ul style="list-style-type: none"> <li>• An attempt was made to make an S-VHS/VHS recording of a signal from an i.LINK device other than a digital tuner*.</li> <li>• The i.LINK connector on this VCR is intended only for D-VHS recording. This VCR does not convert a digital signal into an analog signal for recording. Switch to the analog input for recording.</li> </ul>
107	"CAN NOT REC DIGITAL INPUT BY S- VHS/VHS" "USE ANALOG TIMER PROGRAMMING"	<ul style="list-style-type: none"> <li>• An attempt was made to make an S-VHS/VHS recording using the timer function with "i.LINK" selected on the digital tuner* side.</li> <li>• The i.LINK connector on this VCR is intended only for D-VHS recording. This VCR does not convert a digital signal into an analog signal for recording. Also, it is not possible to make a D-VHS recording on VHS tape. Switch to the analog input for recording.</li> </ul>
108	"REC BY HS MODE"	<ul style="list-style-type: none"> <li>• When 720p, 1080i signals are recorded in STD/LS3 mode, select HS mode to record program properly.</li> </ul>
200	"CAN NOT DECODE VIDEO OR AUDIO USE SET TOP BOX OR HDTV TUNER"	<ul style="list-style-type: none"> <li>• An attempt was made to play back a signal that is not supported by this VCR.</li> <li>• To play back the signal, use the digital tuner*, etc., that was used to record the signal.</li> </ul>
201	"WAIT A MINUTE CALIBRATING. . ."	<ul style="list-style-type: none"> <li>• Normal playback is being prevented by mosaic noise, etc.</li> <li>• Wait while the VCR calibrates itself so that it can output a normal image.</li> </ul>
202	"COPY RESTRICTED PROG OUTPUT 480i VIDEO"	<ul style="list-style-type: none"> <li>• When playing back a program that was copy protected in 1080i, 720p, or 480p mode, the VCR down-converts to 480i mode for output.</li> </ul>
203	"COPY RESTRICTED PROG CAN NOT PLAY BACK"	<ul style="list-style-type: none"> <li>• An attempt was made to play back a tape containing a copy protected program.</li> <li>• Even if you record a copy protected program, this VCR cannot play it back.</li> </ul>
205	"CAN NOT PLAY BACK THIS TAPE"	<ul style="list-style-type: none"> <li>• An attempt was made to play back a tape containing an invalid D-VHS recording.</li> </ul>

CODE	MESSAGE	DESCRIPTION
300	"CAN NOT DECODE VIDEO OR AUDIO USE SET TOP BOX OR HDTV TUNER"	<ul style="list-style-type: none"> <li>• A signal format that is not supported by this VCR was input.</li> <li>• Use a digital tuner*, etc.</li> </ul>
301	"TOO MANY i.LINK INSTRUMENTS READ INST.BOOK"	<ul style="list-style-type: none"> <li>• A signal containing too much data was input to the i.LINK connector on this VCR.</li> <li>• There are too many devices with i.LINK connectors, such as VCRs and digital video cameras, connected to the i.LINK connector on this VCR. Turn off any devices that are not in use.</li> </ul>
302	"COPY RESTRICTED PROG OUTPUT 480i VIDEO"	<ul style="list-style-type: none"> <li>• When playing back a program that was copy protected in 1080i, 720p, or 480p mode, the VCR down-converts to 480i mode for output.</li> </ul>
303	"VIDEO SIGNAL IS NOT FOUND FOR THIS PROGRAM"	<ul style="list-style-type: none"> <li>• An attempt was made to play back a tape that does not contain video signal.</li> </ul>
304	"THIS PROGRAM CAN NOT PLAY BACK THE CONTENT IS NOT ACCEPTABLE"	<ul style="list-style-type: none"> <li>• An attempt was made to play back a tape that contains copy information that is not compatible with this VCR.</li> </ul>
305	"OUTPUT PROHIBITED DUE TO TV WITHOUT HDCP COPY PROTECTION"	<ul style="list-style-type: none"> <li>• An error has occurred due to an attempt to output through the HDMI output connector to the TV that is not HDCP-compliance.</li> </ul>

\* For details of a digital tuner, refer to the instruction manual of the digital tuner.

## Questions and answers

### PLAYBACK

- Q. What happens if the tape reaches its end during playback or search?**  
 A. The VCR automatically rewinds it to the beginning.
- Q. Can the VCR indefinitely remain in still mode?**  
 A. No. It stops automatically after 5 minutes to protect the heads.
- Q. During picture search, still picture playback and frame-by-frame playback, the picture is intermittent. What's the cause?**  
 A. Picture loss occurs when these types of playback are attempted with a tape recorded in LP mode. Pressing [PLAY (▶)] to return to normal playback will restore the picture.
- Q. When returning from variable-speed picture search to normal playback, the picture is disturbed. Should I be concerned about this?**  
 A. No, it is normal.
- Q. When playing back programs that have been timer-recorded consecutively (such that one program from 8:00 to 9:00 and another one from 9:00 to 10:00), the picture and sound become momentarily distorted where the first program ends and the second program begins. Is this a malfunction?**  
 A. No. This is normal.
- Q. Other than preventing further recording, what effect does removing the safety tab have?**  
 A. It disables marking of index codes and tape numbers for Video Navigation.
- Q. Sometimes, during index search, the VCR cannot find the program I want to see. Why not?**  
 A. There may be index codes too close together.
- Q. During playback, on-screen display sometimes jitters. Why does this happen?**  
 A. If the condition of the tape being played back is not good, jittering of the video (including on-screen display) may occur.

### RECORDING

- Q. When I pause and then resume a recording, the end of the recording before the pause is overlapped by the new recording. Why does this happen?**  
 A. This is normal. It reduces distortion at the pause and resume points.
- Q. Can the VCR indefinitely remain in the recording pause mode?**  
 A. No. The VCR automatically stops after 5 minutes to protect the heads. When paused during Instant Timer Recording (ITR), the VCR shuts off automatically after 5 minutes.
- Q. What happens if the tape reaches its end during recording?**  
 A. The VCR stops, then [○] and [▷] blink on the front display panel.

### TIMER RECORDING

- Q. [○] and [⊙] remain lit on the front display panel. Is there a problem?**  
 A. No. This is a normal condition for a timer recording in progress.
- Q. Can I program the timer while I'm watching a tape or a TV broadcast?**  
 A. Yes, but while you are setting the timer you will not see the tape's or broadcast program's picture as it is replaced by the on-screen menu. (The sound from the tape or broadcast program will be heard during the timer setting.)

## Glossary

### Digital Broadcasts and D-VHS

Great changes in the entertainment and media industries are transforming the way we use VHS, and digital broadcasting is a good example of what the future holds. Digital broadcasting now allows more efficient use of the limited broadcast spectrum besides delivering high-definition video, outstanding sound quality, multiple channels, and multiple features.

Meanwhile, VHS has evolved with the advances in broadcasting in response to the need for continued use of existing VHS resources and the trend toward digital broadcasts.

Digital broadcasting is not limited to transmissions of audio and video content. A variety of other data can be sent as well. As the means to record all of these digital signals while supporting playback of the extensive VHS library of analog tapes, D-VHS was developed.

This VCR is equipped with an MPEG-2 encoder and decoder (codec) for digital recording and playback of analog signals.

D-VHS is the key to a smooth transition from analog to digital formats. This next-generation home video technology lets us continue to enjoy home video entertainment as popularized in the last century well into the next.

### Dolby Digital

A form of digital audio coding developed by Dolby Laboratories to deliver surround sound with 5.1 channels (front left and right, center, rear left and right, and a channel for LFE (low-frequency effects)).

When you play back a digital tape encoded in Dolby Digital format, the Dolby Digital bitstream is sent from the DIGITAL OUT OPTICAL connector.

Set "OPTICAL OUT" to "Dolby D" (🔊 page 64).

Manufactured under license from Dolby Laboratories. Dolby, Pro Logic, and the double-D symbol are trademarks of Dolby Laboratories. Confidential unpublished works. Copyright 1992-1997 Dolby Laboratories. All rights reserved.

### DTS

Abbreviation for Digital Theater Systems. A digital surround sound system for theaters, developed by Digital Theater Systems, Inc, of the United States. The encoding format, similar to Dolby Digital, is configured with six (5.1) channels. The sound data is compressed when it is recorded on the medium (CD-ROM), however since the level of compression is low, superior clarity and depth in sound is achieved.

As this VCR is not equipped with a DTS decoder, connect the [OPTICAL] terminal to an AV amplifier with built-in DTS and set "OPTICAL OUT" to "STREAM" (🔊 page 64) to output digital surround sound.

*DTS, DTS Digital Out are trademarks of Digital Theater Systems, Inc.*

### HDCP

Abbreviation for High-bandwidth Digital Content Protection. HDCP is a specification originally developed by Intel Corporation to enforce copyrights of digital entertainment content across the DVI interface, and now across the HDMI interface as well.

### HDMI

Abbreviation for High-definition Digital Multimedia Interface. HDMI which was built on the foundation of DVI-HDCP, transmits uncompressed high definition video and multichannel digital audio in a single cable with a maximum data transfer speed of 5Gbits/sec. HDMI eliminates the maze of cables behind entertainment systems while maintaining backward compatibility with DVI-HDCP devices.

HDMI supports uncompressed standard, enhanced and high definition video format as well as compressed audio formats such as Dolby Digital, DTS and uncompressed format such as PCM etc. In addition, it also supports the HDCP standard of digital video signals.

*HDMI, the HDMI logo and High-Definition Multimedia Interface are trademarks or registered trademarks of HDMI Licensing LLC.*

### i.LINK

i.LINK is a digital serial interface that allows devices equipped with an i.LINK connector to exchange digital video signals, digital audio signals, and device control signals bi-directionally over a single cable.

*i.Link refers to the IEEE1394-1995 industry specification and extensions thereof. The  logo is used for products compliant with the i.Link standard.*

### Linear PCM Audio

Conventional D-VHS recording uses MPEG-1 Layer 2 compression to record analog audio digitally. For recording without compression, this VCR also features PCM recording (pulse code modulation: 48 kHz, 16-bit, 1536 kbps).

Used with high-resolution HS/STD mode, it offers outstanding high-fidelity recording and playback. (Recording from audio input alone is not supported.)

### MPEG2

Abbreviation for Moving Picture Experts Group, Phase 2. Unlike previous compression methods, MPEG-2 uses an extremely efficient compression method that supports high-definition video. Based on the principle that much video data remains unchanged from one frame to the next, predictive coding is performed to eliminate redundant data.

Specifically, compression is applied between frames (based on the correlation of frame data) and within frames (based on DCT, or discrete cosine transform) for an extremely efficient compression technique.

## List of terms

This guide serves as a quick way to locate frequently used terms and on-screen display names.

- A**  
 Accidental erasure prevention 39  
 Audio Monitor 30  
 Auto Daylight Saving Time 18  
 AUTO SP→ EP TIMER 66  
 AUTO TIMER 66  
 Automatic tracking 30  
 AV COMPU-LINK 67
- C**  
 Cable box setting  
   Brand 23  
   Input channel 23  
   Installing Controller 22  
 Clock setting  
   Manual setting 19  
   Preparations 17  
   Semiauto setting 18  
 Clock time 37  
 Connection 12  
   Connection to TV 13  
   Component Video Connection 13  
   Digital Set Top Box Connection 15  
   HDMI Connection 13, 15  
   VIDEO/S-VIDEO connection 13  
 Contents 6  
 Counter reset 10, 29
- D**  
 DBS receiver setting  
   Brand 26  
   Input channel 26  
   Installing Controller 25  
 DISPLAY 68  
 DV AUDIO REC 64
- E**  
 Editing  
   i.LINK/DV Connections 72  
   Remote Pause function 67  
   S-VIDEO/VIDEO Connections 74  
 Express timer programming 44
- F**  
 FRONT AUX F-1 65
- G**  
 GRAY BACK 66  
 Guide channel 42  
 Glossary 87
- H**  
 HDMI OUTPUT 65  
 HDMI to DVI COLOR 65  
 Host channel 16
- I**  
 Index  
   Front display panel 9  
   Front panel 7  
   Rear panel 8  
   Remote 11  
   On-screen display 10  
 Index Search 31  
 Instant Timer Recording (ITR) 37  
 i.LINK Setting 70
- J**  
 JLIP ID Number Setting 69
- L**  
 LIGHTING 68
- M**  
 Manual tracking 30  
 Multi-Brand Remote  
   Controlling four JVC VCRs 78  
   Setting Cable Box brand 77  
   Setting DBS receiver brand 77  
   Setting TV brand 76
- N**  
 Next Function Memory 31
- O**  
 On-screen display 10, 38  
 OPTICAL OUT 64
- P**  
 PBS channel 16  
 PICTURE CONTROL 63  
 Playback 28  
 Plug & Play 16  
 POWER SAVE 67
- R**  
 REAR AUX L-1 66  
 REAR AUX L-2 66  
 Recording  
   D-VHS Recording via i.LINK  
     Connection 35  
   D-VHS/S-VHS/VHS Recording 36  
 Recording speed 35, 36, 73  
 Repeat playback 29
- S**  
 Satellite Auto Recording 47  
 Skip Search 31  
 Special effect playback  
   Frame-by-Frame Playback 34  
   High-Speed Picture Search 33  
   Picture Search 33  
   Slow Motion Playback 34  
   Still Picture Playback 34  
   Variable-Speed Picture Search 33  
 Specifications 89  
 STD AUDIO REC MODE 64  
 SUPERIMPOSE 66  
 S-VHS ET 68  
 S-VHS MODE 67
- T**  
 Tape position indicator 29  
 Tape remaining time 10, 37  
 Time counter 10, 37  
 Time zone selection 18  
 Timer recording  
   Canceling 46  
   Changing 46  
   Checking 46  
   Express 44  
   Guide channel setting 42  
   Overlap 50  
   VCR Plus+ 40  
 Tracking 30  
 Troubleshooting 79  
 Tuner setting  
   Adding channels 21  
   Auto Channel Set 20  
   Manual Channel Set 21  
   Skipping channels 21  
 TV OUTPUT 1 65  
 TV OUTPUT 2 65
- V**  
 VCR Plus+ Setting 42  
 VCR Plus+ Timer programming 40  
 V. CALIBRATION 63  
 Video Navigation  
   Checking memory 61  
   Editing titles 57  
   Finding tapes 53  
   Playback 51  
 VIDEO STABILIZER 63  
 2ND AUDIO REC 64  
 480i to 480p 65



## GENERAL

Power requirement	: AC 120 V $\sim$ , 60 Hz
Power consumption	
Power on	: 45 W
Power off	: 14 W
Temperature	
Operating	: 5°C to 40°C (41°F to 104°F)
Storage	: -20°C to 60°C (-4°F to 140°F)
Operating position	: Horizontal only
Dimensions (W x H x D)	: 435 mm x 96 mm x 376 mm (17-3/16" x 3-4/5" x 14-4/5")
Weight	: 5.1 kg (11.2 lbs)
Maximum recording time	
D-VHS (HS)	: 210 min. with DF-420 video cassette
D-VHS (STD)	: 420 min. with DF-420 video cassette
D-VHS (LS3)	: 1260 min. with DF-420 video cassette
S-VHS/VHS (SP)	: 210 min. with ST-210 video cassette
S-VHS/VHS (EP)	: 630 min. with ST-210 video cassette

## VIDEO/AUDIO (D-VHS)

Video format	: MPEG2 standard
Audio format	: Encode MPEG1 Layer2 Decode MPEG1 Layer2/ Dolby Digital LINEAR PCM (HS/STD)
Track composition	
Tape speed	: 33.4 mm/sec (HS mode) 16.67 mm/sec (STD mode) 5.55 mm/sec (LS3 mode)
Head azimuth	: $\pm 30$ deg
Drum rotation	: 1800 rpm
Tracking system	: CTL track system
Recording specification	
Main data input rate:	28.2 Mbps (HS mode) 14.1 Mbps (STD mode) 4.7 Mbps (LS3 mode)
Interface	: IEEE1394 compliant DTCP digital copy protection compatible

## VIDEO/AUDIO (S-VHS/VHS)

Format	: S-VHS/VHS NTSC standard
Signal system	: NTSC-type color signal and EIA monochrome signal, 525 lines/60 fields
Recording/ Playback system	: DA-4 (Double Azimuth) head helical scan system
Signal-to-noise ratio	: 45 dB
Frequency range	
Normal audio	: 70 Hz to 10,000 Hz
Hi-Fi audio	: 20 Hz to 20,000 Hz

## TUNER

Tuning system	: Frequency-synthesized tuner
Channel coverage	
VHF	: Channels 2-13
UHF	: Channels 14-69
CATV	: 113 Channels

## TIMER

Clock reference	: Quartz
Program capacity	: 1-year programmable timer/ 24 programs
Memory backup time	: Approx. 10 min.

## CONNECTORS

Input/Output	
Antenna	: 75 $\Omega$ , F-type
S-video input	
Y	: 0.8 - 1.2 Vp-p, 75 $\Omega$
C	: 0.2 - 0.4 Vp-p, 75 $\Omega$
S-video output	
Y	: 1.0 Vp-p, 75 $\Omega$
C	: 0.29 Vp-p, 75 $\Omega$
Video input	: 0.5 - 2.0 Vp-p, 75 $\Omega$ (pin jack)
Video output	: 1.0 Vp-p, 75 $\Omega$ (pin jack)
Audio input	: -8 dB, 50 k $\Omega$ (pin jack) Corresponding to mono (left)
Audio output	: -8 dB, 1 k $\Omega$ (pin jack)
i.Link	: 4-pin (S400) for MPEG2 input/output, DV input
Component video output	
Y	: 1.0 Vp-p, 75 $\Omega$
CB/CR, PB/PR	: 0.7 Vp-p, 75 $\Omega$
HDMI output	: 19-pin Corresponding to HDCP
JLIP	: $\varnothing$ 3.5 mm
AV Compulink	: $\varnothing$ 3.5 mm
CABLE BOX	: $\varnothing$ 3.5 mm
Digital audio output	
Optical	: -18 dBm, 660 nm Corresponding to Dolby Digital and DTS Digital Surround Bit stream. Selectable in digital audio output setting menu.

## ACCESSORIES

Provided accessories	: Infrared remote control unit, AA battery x 2, Audio cable, RF cable (F-type), S-video cable (4-pin), Controller
----------------------	--

*Specifications shown are for SP mode unless specified otherwise.*

*E. & O.E. Design and specifications subject to change without notice.*



LIMITED WARRANTY

USA ONLY

ONLY FOR PRODUCT PURCHASED IN U.S.A. CONSUMER VIDEO 1-90

JVC COMPANY OF AMERICA (JVC) warrants this product and all parts thereof, except as set forth below ONLY TO THE ORIGINAL RETAIL PURCHASER to be FREE FROM DEFECTIVE MATERIALS AND WORKMANSHIP from the date of original purchase for the period shown below. ("The Warranty Period")

PARTS	1 YR	LABOR	90 DAYS
-------	------	-------	---------

THIS LIMITED WARRANTY IS VALID ONLY IN THE FIFTY (50) UNITED STATES, THE DISTRICT OF COLUMBIA AND IN THE COMMONWEALTH OF PUERTO RICO.

WHAT WE WILL DO:

If this product is found to be defective within the warranty period, JVC will repair or replace defective parts with new or rebuilt equivalents at no charge to the original owner. Such repair and replacement services shall be rendered by JVC during normal business hours at JVC authorized service centers. Parts used for replacement are warranted only for the remainder of the Warranty Period. All products may be brought to a JVC authorized service center on a carry-in basis. Color televisions with a screen size of 27" or greater qualify for in-home service. In such cases, a technician will come to your home and either repair the TV there or remove and return it if it cannot be repaired in your home.

WHAT YOU MUST DO FOR WARRANTY SERVICE:

Please do not return your product to the retailer. Instead, return your product to the JVC authorized service center nearest you. If shipping the product to the service center, please be sure to package it carefully, preferably in the original packaging, and include a brief description of the problem(s). Please call 1-800-252-5722 to locate the nearest JVC authorized service center. Service locations can also be obtained from our website http://www.jvc.com. If your product qualifies for in-home service, the service representative will require clear access to the product. If you have any questions concerning your JVC Product, please contact our Customer Relations Department at 800-252-5722.

WHAT IS NOT COVERED:

- This limited warranty provided by JVC does not cover:
  - Products which have been subject to abuse, accident, alteration, modification, tampering, negligence, misuse, faulty installation, lack of reasonable care, or if repaired or serviced by anyone other than a service facility authorized by JVC to render such service, or if affixed to any attachment not provided with the products, or if the model or serial number has been altered, tampered with, defaced or removed;
  - Initial installation, installation and removal from cabinets or mounting systems;
  - Operational adjustments covered in the Owner's Manual, normal maintenance, video and audio head cleaning;
  - Damage that occurs in shipment, due to act of God, and cosmetic damage;
  - Signal reception problems and failures due to line power surge;
  - Video Pick-up Tubes/CCD Image Sensors are covered for 90 days from the date of purchase;
  - Accessories;
  - Batteries (except that Rechargeable Batteries are covered for 90 days from the date of purchase);
  - Products used for commercial purposes, including, but not limited to rental.

There are no express warranties except as listed above.

THE DURATION OF ANY IMPLIED WARRANTIES, INCLUDING THE IMPLIED WARRANTY OF MERCHANTABILITY, IS LIMITED TO THE DURATION OF THE EXPRESS WARRANTY HEREIN.

JVC SHALL NOT BE LIABLE FOR ANY LOSS OF USE OF THE PRODUCT, INCONVENIENCE, OR ANY OTHER DAMAGES, WHETHER DIRECT, INCIDENTAL OR CONSEQUENTIAL (INCLUDING, WITHOUT LIMITATION, DAMAGE TO TAPES, RECORDS OR DISCS) RESULTING FROM THE USE OF THIS PRODUCT, OR ARISING OUT OF ANY BREACH OF THIS WARRANTY. ALL EXPRESS AND IMPLIED WARRANTIES, INCLUDING THE WARRANTIES OF MERCHANTABILITY AND FITNESS FOR PARTICULAR PURPOSE, ARE LIMITED TO THE WARRANTY PERIOD SET FORTH ABOVE.

Some states do not allow the exclusion of incidental or consequential damages or limitations on how long an implied warranty lasts, so these limitations or exclusions may not apply to you. This warranty gives you specific legal rights and you may also have other rights which vary from state to state.

JVC COMPANY OF AMERICA
DIVISION OF JVC AMERICAS CORP.

1700 Valley Road
Wayne, NJ 07470

http://www.jvc.com



REFURBISHED PRODUCTS CARRY A SEPARATE WARRANTY, THIS WARRANTY DOES NOT APPLY. FOR DETAIL OF REFURBISHED PRODUCT WARRANTY, PLEASE REFER TO THE REFURBISHED PRODUCT WARRANTY INFORMATION PACKAGED WITH EACH REFURBISHED PRODUCT.

For customer use:

Enter below the Model No. and Serial No. which is located either on the rear, bottom or side of the cabinet. Retain this information for future reference.

Model No.:

Serial No.:

Purchase date:

Name of dealer:



FOR SERVICING (Only in U.S.A.)

## TO OUR VALUED CUSTOMER

THANK YOU FOR PURCHASING THIS JVC PRODUCT.  
WE WANT TO HELP YOU ACHIEVE A PERFECT EXPERIENCE.

**NEED HELP ON HOW TO HOOK UP?  
NEED ASSISTANCE ON HOW TO OPERATE?  
NEED TO LOCATE A JVC SERVICE CENTER?  
LIKE TO PURCHASE ACCESSORIES?**

# JVC IS HERE TO HELP!

**TOLL FREE: 1 (800) 252-5722**  
**<http://www.jvc.com>**

Remember to retain your Bill of Sale for Warranty Service.

**Do not attempt to service the product yourself**

### Caution

To prevent electrical shock, do not open the cabinet.  
There are no user serviceable parts inside.  
Please refer to qualified service personnel for repairs.

## ATTENTION

- JVC EXPRESSLY DISCLAIMS ALL WARRANTIES, EXPRESS OR IMPLIED, AND SHALL NOT BE LIABLE FOR ANY AND ALL DAMAGES, CLAIMS OR LIABILITIES, DIRECT OR INDIRECT, ARISING FROM OR RELATING TO THE USE OF THIS PRODUCT WITH ANY OTHER PRODUCT, DEVICE, COMPONENT, PART OR MATERIAL THAT IS NON-CONFORMING OR NON-COMPATIBLE WITH THIS PRODUCT.
- THE i.LINK/DV CONNECTION OF THIS PRODUCT CONFORMS TO IEC61883-1; IEC61883-2; IEC61883-4; IEEE STD 1394-1995; IEEE STD 1394A-2000; 1394 INTERFACE IMPLEMENTATION GUIDELINE FOR D-VHS VERSION 1.00 AND DTCP (DIGITAL TRANSMISSION CONTENT PROTECTION) SPECIFICATION VERSION 1.1 (THE "SPECIFICATIONS"). USE OF THIS PRODUCT WITH AN OTHER PRODUCT, DEVICE, COMPONENT, PART OR MATERIAL THAT IS NOT IN CONFORMITY OR COMPLIANT WITH THE SPECIFICATIONS, OR THAT IMPLEMENT THE SPECIFICATIONS IN A NON-CONFORMING OR NON-COMPATIBLE MANNER WITH THIS PRODUCT, MAY NOT BE SUPPORTED AND MAY CAUSE DAMAGE TO OR MALFUNCTION OF THIS PRODUCT. ANY USE OF THIS PRODUCT WITH A NON-CONFORMING OR NON-COMPATIBLE PRODUCT, DEVICE, COMPONENT, PART OR OTHER MATERIAL SHALL BE AT THE USER'S SOLE AND EXCLUSIVE RISK.

# JVC

HM-DHSU